



BH1A2500A Aluminium rolkrik



PRODUCTGEGEVENS

- 2.5T rolkrik met 100% aluminium structuur voor weg- en werkplaatsdiensten
- Weegt slechts 24,4 kg
- Lage insteekhoogte: 100 mm
- Hoge hefhoogte: 485 mm
- Snelle benadering van de lading dankzij het dubbele zuigersysteem
- Stofkap beschermt de zuigers en de veer tegen beschadiging
- Uitgerust met een handige gereedschapslade
- Foam en rubber moffen op de hendel voorkomt schade aan de carrosserie van het voertuig
- Nylon voor- en achterwielen zorgen voor uitstekende stabiliteit en geruisloos werken
- CE-gecertificeerd door Official Independent Technical Inspection Association

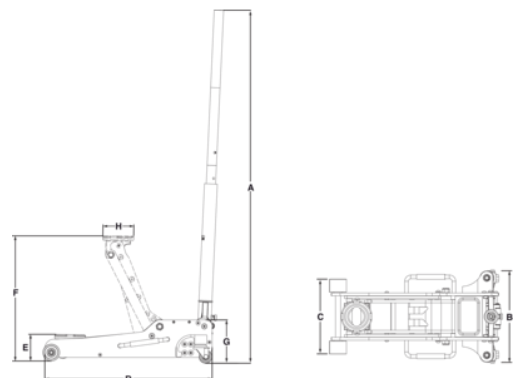









Follow the Fish!



PRODUCTKENMERKEN

Product: **BH1A2500A**

	2500 kg		100 mm		485 mm
	655 mm		6		116 mm
	-		Yes	A	1380 mm
B	350 mm	C	278 mm	D	655 mm
E	100 mm	F	485 mm	G	163 mm
H	116 mm		24.4 kg		

