

Model No.DF001D IN-LINE CORDLESS SCREWDRIVER

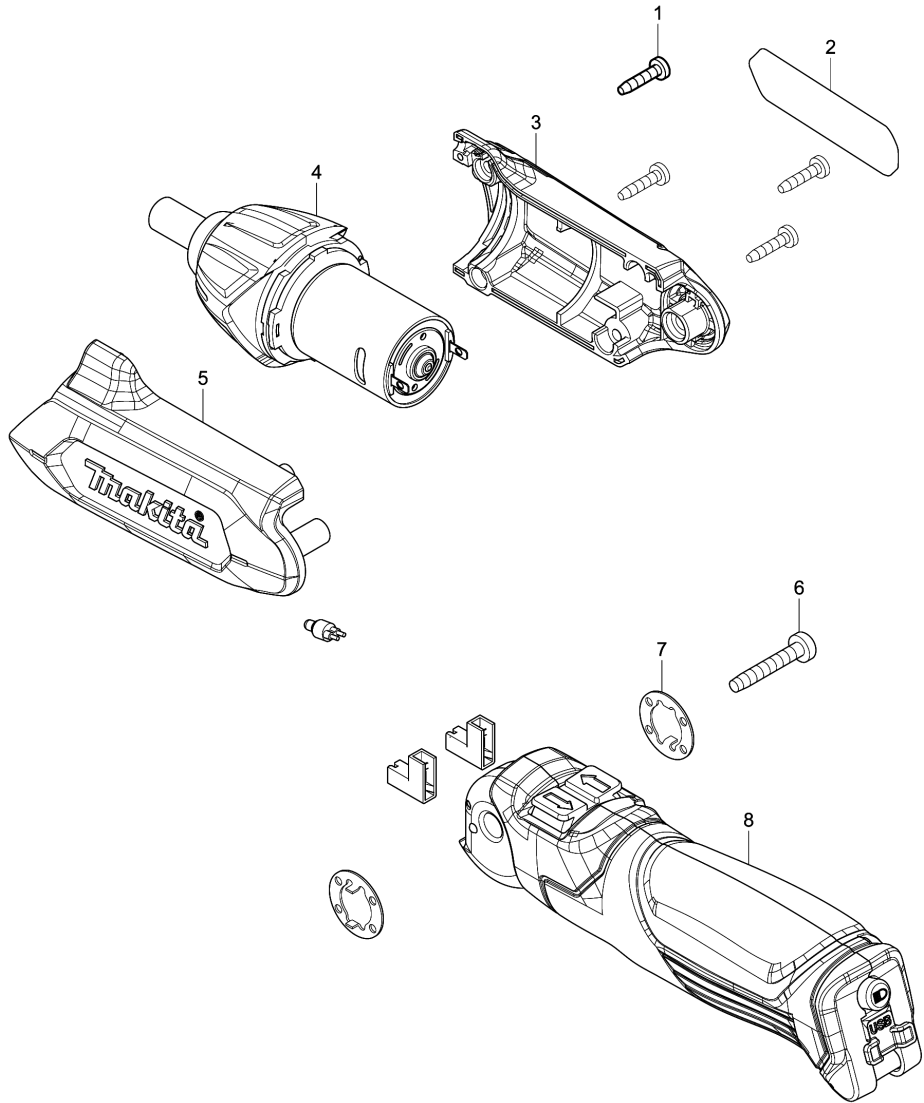

Model No.DF001D IN-LINE CORDLESS SCREWDRIVER

Item	Parts No.	Description	I/C	Qty	New/Old	Opt. 1	Opt. 2	Note
001	266404-8	TAPPING SCREW BIND 3X14		4				
002	852X12-1	DF001D NAME PLATE		1				
003	183F38-7	MOTOR HOUSING SET		1				
D10		INC. 5						
004	123910-5	GEAR ASSEMBLY(EMC COMPLIANT)		1				
C10	221532-6	SPUR GEAR 20B		3				
C20	221531-8	MOTOR PINION		1				
C30	629245-7	DC MOTOR		1				
C40	265172-0	+PAN HEAD SCREW M2.6X6		2				
005	183F38-7	MOTOR HOUSING SET		1				
D10		INC. 3						
006	266374-1	TAPPING SCREW 4X25		1				
007	267803-7	LOCK WASHER		2				
008	620628-4	CONTROLLER ASSEMBLY		1	*			
008-1	620694-1	BATTERY INTEGRATED CONTROLLER		1				
A01	D-61519	BIT CASE SET C		1				
A02	630A38-3	ADP07 AC ADAPTER		1	*			
A02-1	198363-7	ADP07 AC ADAPTER SET	<	1				
A03	661750-8	USB CABLE		1	*			
A03-1	661753-2	USB CABLE	O	1				
A04	821704-9	PLASTIC CASE		1				

Please order the parts with part number.

Print Date 30/1/2020