

Quick Guide

EN	2
CZ	5
DE	8
EL	11
ES	14
FR	17
IT	20
NL	23
PL	26
PT	29
SK	32
TR	35
BS	38
DA	41
FI	44
HU	47
NO	50
RU	53
RO	56
SL	59
SV	62



List of icons with explanation

- | | | | | | |
|---|---|---|---|---|--|
|  | Special safety precautions when working with electric secateurs |  | Wear safety glasses |  | Equipment complying with EC standards |
|  | Risk of injury – keep hands away from cutting head |  | Wear safety gloves |  | Equipment complying with UK CA standards |
|  | Do not expose to rain, water or wet conditions |  | Read the user guide |  | Equipment complying with the requirements imposed or covered by regulations in Australia and New Zealand |
|  | Keep away from heat sources |  | Do not put to general waste |  | Battery system complying with the California Energy Commission efficiency requirements |
|  | Do not use damaged or broken batteries |  | Recycle in accordance with local waste regulation | | |

1. Getting started

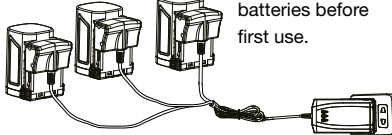
- 

Fully charge batteries before first use.
- 

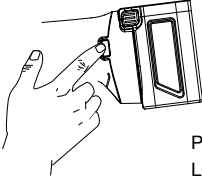
Insert battery into the secateurs.
- 

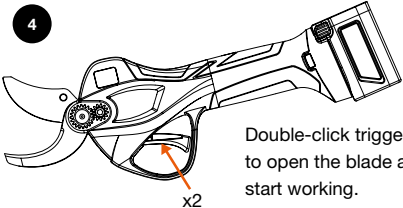

Press on/off button. LCD display becomes on and one beep sounds.
- 

Double-click trigger to open the blade and start working.

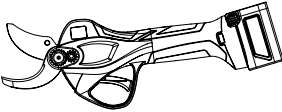
2. Change the blade opening

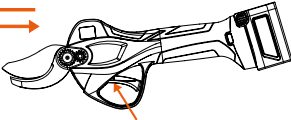
- 

Full opening 37 mm
- 

To change opening keep trigger pressed 2 sec. 
- 

Half opening 25 mm

3. Change the blade



Remove the cover of the blade driving system.



Turn the tool around and unscrew the center bolt lock.



Unscrew the center bolt.



Remove the center bolt.



Take out and separate the driving system and the blade.



Remove the counter blade if it is necessary to change it.



Clean and grease all parts including the pinion.

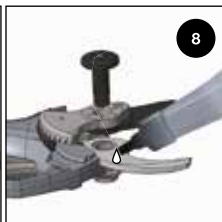

Assemble driving system and blade and fix by inserting the center bolt.



Tighten the central nut (0.2 Nm).



Tighten the center bolt lock.

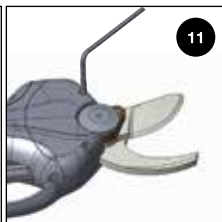

Put back the cover and tighten the upper screw.

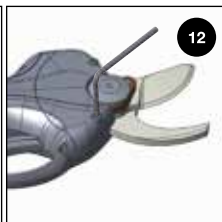

Tighten the lower screw.

4. At the end of a working day



1

Press trigger for a few seconds to close 3 sec. blades.

2

Switch off the tool.

3

Disconnect the battery.

4

Charge battery.

5

Clean cutting head.

6

Lubricate cutting head.

24h

7

Sharpen the blade with SHARP-X or LS CORINDON.

SHARP-X

x5

x1

LS CORINDON

x10

x1

Seznam ikon s vysvětlením



Při práci s elektrickými zahradnickými nůžkami dodržujte speciální bezpečnostní opatření



Používejte ochranné brýle



Zařízení splňuje normy ES



Riziko úrazu – nedávejte ruce do oblasti stříhací hlavičky



Používejte ochranné rukavice



Zařízení splňuje normy UK CA



Chraňte před deštěm, vodou a vlhkem



Prostudujte si uživatelskou příručku



Zařízení splňuje požadavky kladené nebo podléhající předpisům v Austrálii a na Novém Zélandu



Uchovávejte mimo zdroje tepla



Nevyhazujte do komunálního odpadu



Akumulátorový systém splňuje požadavky Kalifornské energetické komise na účinnost



Nepoužívejte poškozené ani rozbité akumulátory



Recyklujte v souladu s místními předpisy pro nakládání s odpady

1. Začínáme

1

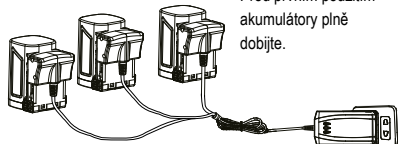

Před prvním použitím akumulátory plně dobijte.

2

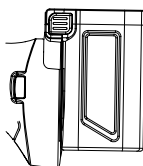

Vložte akumulátor do zahradnických nůžek.

3

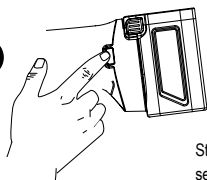

Stisknete vypínač. LCD displej se rozsvítí a zazní jedno pípnutí.

4

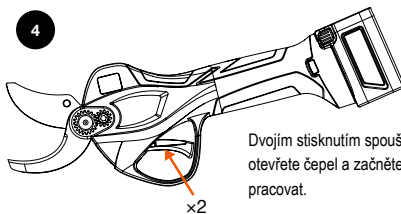

Dvojným stisknutím spouště otevřete čepel a začnete pracovat.

2. Změna rozevření čepele

1

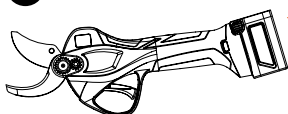

Plné otevření 37 mm

2

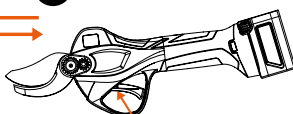

Chcete-li změnit rozevření, stiskněte spoušť

3

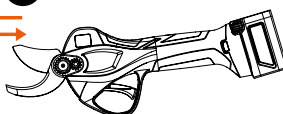

Poloviční otevření 25 mm

2 s

3. Výměna čepele



Sejměte kryt ze systému pohonu čepele.



Nástroj otočte a vyšroubujte pojistku středového šroubu.



Vyšroubujte středový šroub.



Vyjměte středový šroub.



Vyjměte systém pohonu a čepele a oddělte je od sebe.



Vyjměte protější čepele, pokud je potřeba ji vyměnit.



Vyčistěte a namažte všechny díly včetně ozubeného kolečka.

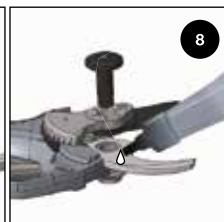

Sestavte systém pohonu a čepele a vše upevněte vložením středového šroubu.

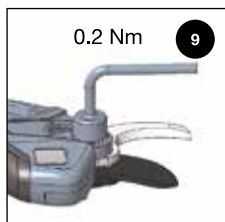

Dotáhněte středovou matici (0,2 Nm).



Dotáhněte pojistku středového šroubu.

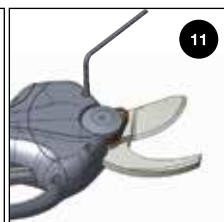

Vraťte zpět kryt a dotáhněte horní šroub.



Dotáhněte spodní šroub.

4. Na konci pracovního dne

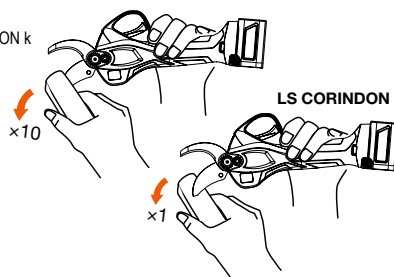
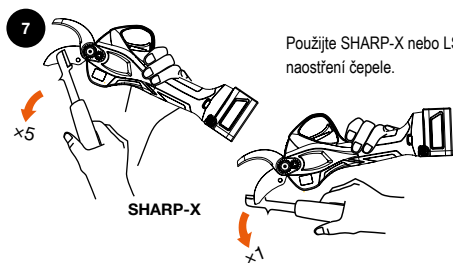
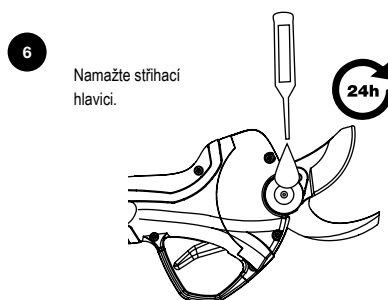
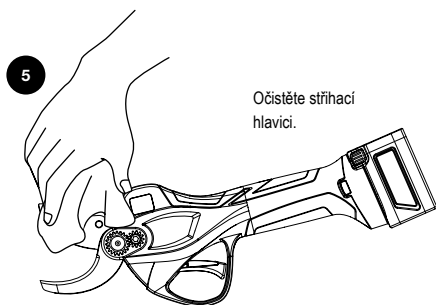
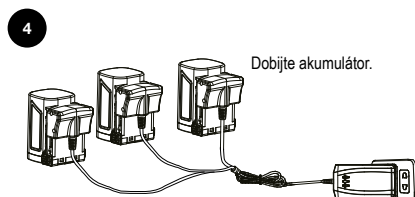
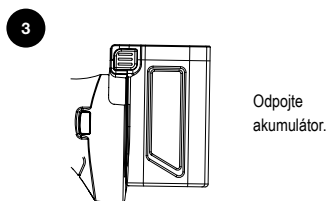
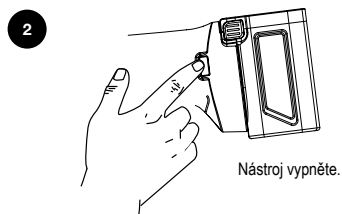
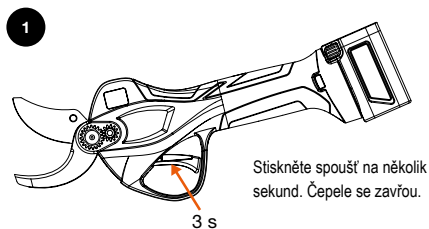

Symbolverzeichnis mit Erklärungen



Besondere Sicherheitsvorkehrungen bei Arbeiten mit elektrischen Rebscheren



Verletzungsgefahr – Hände vom Schneidkopf fernhalten



Vor Regen, Wasser und Nässe schützen



Von Wärmequellen fernhalten



Keine beschädigten oder defekten Akkus verwenden



Schutzbrille tragen



Schutzhandschuhe tragen



Bedienungsanleitung lesen



Nicht im normalen Haushaltsmüll entsorgen



Gemäß vor Ort geltenden Vorschriften zur Abfallentsorgung recyceln



Gerät entspricht EG-Normen



Gerät entspricht britischen CA-Normen



Gerät entspricht den Anforderungen der Vorschriften in Australien und Neuseeland



Akkusystem entspricht den Effizienzanforderungen der California Energy Commission

1. Erste Schritte

1

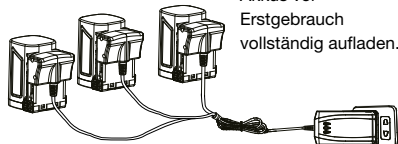

Akkus vor Erstgebrauch vollständig aufladen.

2

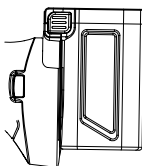

Akku in die Rebschere einsetzen.

3

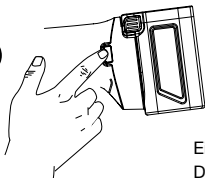

Ein/Aus-Taste drücken. Die LCD-Anzeige leuchtet auf und ein Signalton ertönt.

4

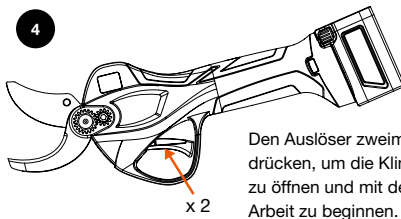

Den Auslöser zweimal drücken, um die Klängen zu öffnen und mit der Arbeit zu beginnen.

2. Messeröffnung ändern

1



Volle Öffnung 37 mm

2

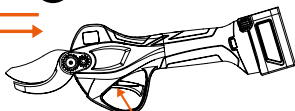

Zum Ändern der Öffnung den Abzug gedrückt halten

3



Halbe Öffnung 25 mm

2 Sek.

3. Austausch der Klinge



Die Abdeckung des Klingenantriebs abnehmen.



Das Gerät umdrehen und die mittlere Schraubverbindung lösen.



Die mittlere Schraube lösen.



Die mittlere Schraube herausnehmen.



Den Antrieb und die Klinge herausnehmen und trennen.



Die Gegenklinge herausnehmen, wenn sie ausgetauscht werden muss.



Alle Teile einschließlich des Ritzels reinigen und schmieren.

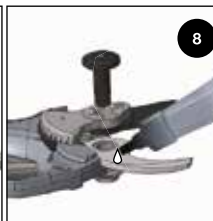

Antrieb und Klinge zusammensetzen und durch Einsatz der mittleren Schraube befestigen.



Die mittlere Mutter festziehen (0,2 Nm).



Die mittlere Schraubverbindung festziehen.

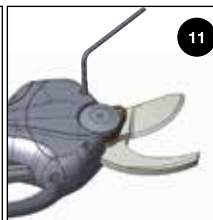

Die Abdeckung wieder anbringen und die obere Schraube festziehen.



Die untere Schraube festziehen.

4. Am Ende eines Arbeitstags



1

3 Sek.

Den Auslöser einige Sekunden lang gedrückt halten, um die Klingen zu schließen.

2

Das Gerät ausschalten.

3

Akku trennen.

4

Akku aufladen.

5

Schneidkopf reinigen.

6

Schneidkopf schmieren.

24h

7

SHARP-X

x 5

x 1

Klingen mit SHARP-X oder LS CORINDON schärfen.

LS CORINDON

x 10

x 1

Λίστα εικονιδίων και επεξήγηση



Ειδικές προφυλάξεις ασφαλείας κατά την εργασία με το ηλεκτρικό κλαδευτόρι



Φοράτε γυαλιά ασφαλείας



Εξοπλισμός σύμφωνος με τα πρότυπα της ΕΚ



Κίνδυνος τραυματισμού – διατηρείτε τα χέρια σας μακριά από την κεφαλή κοπής



Φοράτε γάντια ασφαλείας



Εξοπλισμός σύμφωνος με τα πρότυπα UK CA



Μην εκθέτετε τη ράβδο σε βροχή, νερό ή υγρασία



Διαβάστε τον οδηγό χρήσης



Εξοπλισμός που συμμορφώνεται με τις απαιτήσεις που επιβάλλονται ή καλύπτονται από τους κανονισμούς στην Αυστραλία και τη Νέα Ζηλανδία



Να διατηρείται μακριά από πηγές θερμότητας



Να μην απορρίπτεται με τα γενικά απόβλητα



Σύστημα μπαταριών που συμμορφώνεται με τις απαιτήσεις αποδοτικότητας της Επιτροπής Ενέργειας της Καλιφόρνιας



Μην χρησιμοποιείτε φθαρμένες ή χαλασμένες μπαταρίες



Ανακυκλώνετε σύμφωνα με τους τοπικούς κανονισμούς αποβλήτων

1. Πρώτα βήματα

1

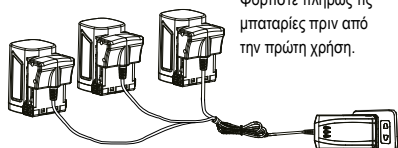

Φορτίστε πλήρως τις μπαταρίες πριν από την πρώτη χρήση.

2

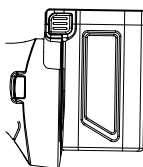

Τοποθετήστε την μπαταρία στο κλαδευτόρι.

3

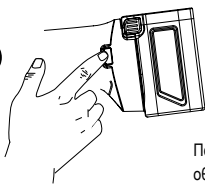

Πατήστε το κουμπί on/off. Η οθόνη LCD γίνεται πράσινη και ακούγεται ένας ηχητικός τόνος.

4

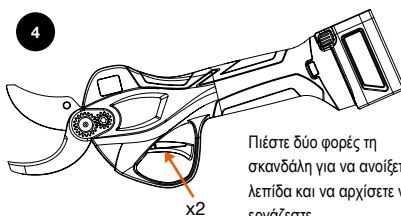

Πιέστε δύο φορές τη σκανδάλη για να ανοίξετε τη λεπίδα και να αρχίσετε να εργάζεστε.

2. Αλλάξτε το άνοιγμα της λεπίδας

1

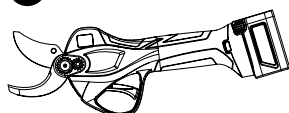

Πλήρες άνοιγμα 37 mm

2

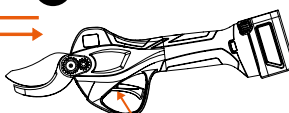

Για να αλλάξετε το άνοιγμα, κρατήστε πατημένη τη σκανδάλη για

3

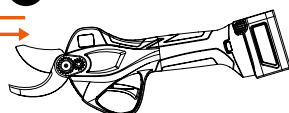

Μισό άνοιγμα 25 mm

2 δευ.

3. Αλλάξτε τη λεπίδα



1 Αφαιρέστε το κάλυμμα του συστήματος κίνησης λεπίδας.



2 Γυρίστε ανάποδα το εργαλείο και ξεβιδώστε την κεντρική βίδα κλειδώματος.



3 Ξεβιδώστε την κεντρική βίδα.



4 Αφαιρέστε την κεντρική βίδα.



5 Αφαιρέστε και διαχωρίστε το σύστημα κίνησης από τη λεπίδα.



6 Αφαιρέστε την αντίστροφη λεπίδα εάν απαιτείται αντικατάστασή της.



7 Καθαρίστε και γρασάρετε όλα τα εξαρτήματα, συμπεριλαμβανομένου του πτερυγίου.

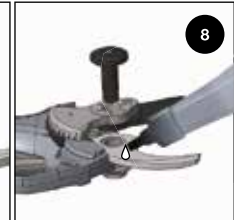

8 Συναρμολογήστε το σύστημα κίνησης και τη λεπίδα και στερεώστε τοποθετώντας την κεντρική βίδα.



9 Σφίξτε το κεντρικό παξιμάδι (0,2 Nm).

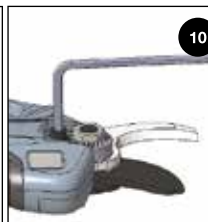

10 Σφίξτε την κεντρική βίδα κλειδώματος.

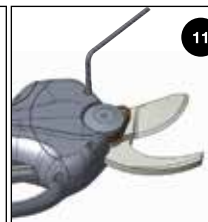

11 Τοποθετήστε ξανά το κάλυμμα και σφίξτε την επάνω βίδα.



12 Σφίξτε την κάτω βίδα.

4. Στο τέλος των εργασιών σας



1

Πιέστε τη σκανδάλη για μερικά δευτερόλεπτα για να κλείσετε τις λεπίδες.
3 δευτ.

2

Απενεργοποιήστε το εργαλείο.

3

Αποσυνδέστε την μπαταρία.

4

Φορτίστε την μπαταρία.

5

Καθαρίστε την κεφαλή κοπής.

6

Λιπάνετε την κεφαλή κοπής.

24h

7

Τροχίστε τη λεπίδα με SHARP-X ή LS CORINDON.

SHARP-X

x5

x1















7

LS CORINDON

x10

x1

Listado de símbolos con su explicación

	Precauciones especiales de seguridad al trabajar con tijeras de poda eléctricas		Usar gafas de seguridad		Equipo conforme a la normativa CE
	Riesgo de lesiones: mantener las manos alejadas del cabezal de corte		Usar guantes de seguridad		Equipo conforme a las normativas de UKCA
	No exponer a la lluvia, al agua o a condiciones húmedas		Leer la guía de usuario		Equipo conforme a los requisitos impuestos o cubiertos por las regulaciones de Australia y Nueva Zelanda
	Mantener el equipo alejado de fuentes de calor		No echar a la basura con los residuos generales		Sistema de batería conforme a los requisitos de eficiencia de la Comisión de Energía de California
	No usar baterías dañadas o rotas		Reciclar de acuerdo con la normativa local sobre residuos		

1. Tareas iniciales

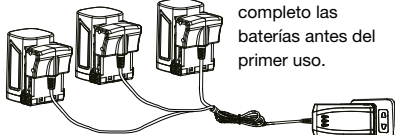
1  Cargue por completo las baterías antes del primer uso.

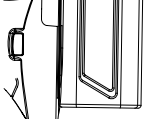

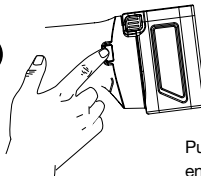
2  Introduzca la batería en las tijeras de poda.

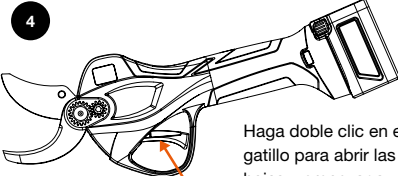
3  Pulse el botón de encendido/apagado. La pantalla LCD se enciende y se oye un pitido.

4  Haga doble clic en el gatillo para abrir las hojas y empezar a trabajar.

2. Cambio de la apertura de la hoja

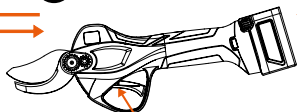
1  Apertura total de 37 mm

2  Para cambiar la apertura, mantenga pulsado el gatillo 2 segundos. 

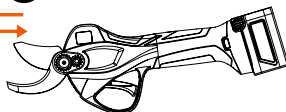
3  Apertura media de 25 mm

3. Sustitución de las hojas



1
Retire la tapa del sistema de accionamiento de la hoja.



2
Gire la herramienta y afloje la retención del perno central.



3
Desatornille el perno central.



4
Retire el perno central.



5
Extraiga y separe el sistema de accionamiento y la hoja.



6
Desmonte la contrahoja si es necesario sustituirla.

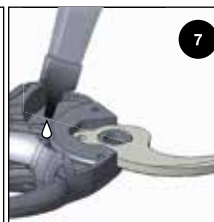

7
Limpie y engrase todas las piezas, incluido el engranaje.

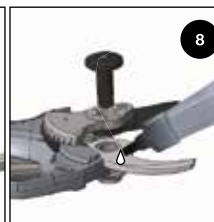

8
Monte el sistema de accionamiento y la hoja para, a continuación, fijar el conjunto introduciendo el perno central.

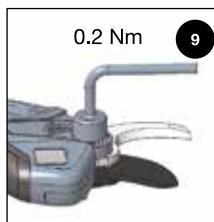

9
0.2 Nm
Apriete la tuerca central (0,2 Nm).

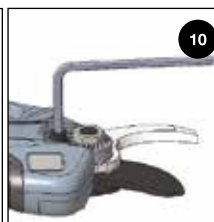

10
Apriete la retención del perno central.

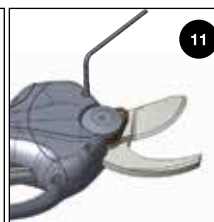

11
Vuelva a colocar la tapa y apriete el tornillo superior.



12
Apriete el tornillo inferior.

4. Al final de la jornada laboral



1

Pulse el gatillo unos segundos para cerrar las hojas.
3 segundos.

2

Apague la herramienta.

3

Desconecte la batería.

4

Cargue la batería.

5

Limpie el cabezal de corte.

6

Lubrique el cabezal de corte.

24h

7

Afile las hojas con un afilador SHARP-X o una piedra de afilado LS CORINDON.

SHARP-X

x5

x1

LS CORINDON

x10

x1

Liste des icônes avec explication associée



Mesures de sécurité particulières à observer lors de l'utilisation du sècheur électrique



Risque de blessure - garder les mains éloignées de la tête de coupe



Ne pas exposer à la pluie, à l'eau ou à l'humidité



Garder à l'écart des sources de chaleur



Ne pas utiliser de batteries endommagées ou détériorées



Porter des lunettes de protection



Porter des gants de protection



Lire le manuel d'utilisation



Ne pas jeter avec les ordures ménagères



Recycler conformément à la réglementation locale en matière de déchets



Équipement conforme aux normes européennes



Équipement conforme aux normes du Royaume-Uni et du Canada



Équipement conforme aux exigences imposées ou couvertes par les réglementations en Australie et en Nouvelle-Zélande



Système de batteries conforme aux exigences de rendement de la California Energy Commission

1. Mise en route

1

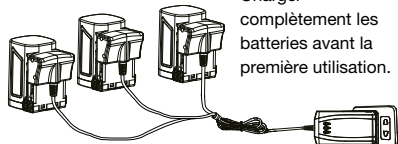

Charger complètement les batteries avant la première utilisation.

2

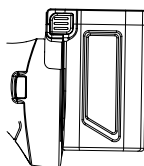

Introduire la batterie dans le sècheur.

3

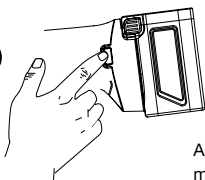

Appuyer sur le bouton marche/arrêt. L'écran LCD s'allume et un bip se fait entendre.

4

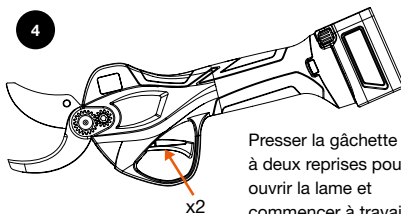

Presser la gâchette à deux reprises pour ouvrir la lame et commencer à travailler.

2. Changer l'ouverture de la lame

1

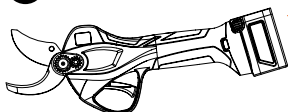

Ouverture complète
37 mm

2

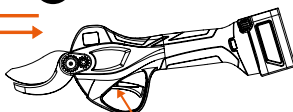

Pour changer l'ouverture, maintenir la gâchette enfoncée

3

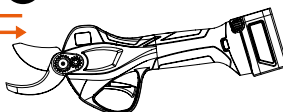

Demi-ouverture 25 mm

2 secondes

3. Changer la lame



Enlever la coque du système d'entraînement de lame.



Retourner l'outil et dévisser le dispositif de verrouillage du boulon central.

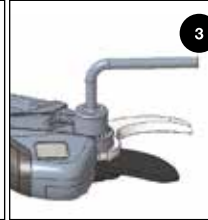

Dévisser le boulon central.



Enlever le boulon central.



Sortir et désaccoupler le système d'entraînement et la lame.



Enlever la contre-lame s'il s'avère nécessaire de la changer.



Nettoyer et graisser toutes les pièces y compris la crémaillère.

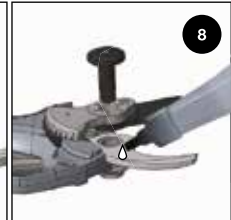

Assembler le système d'entraînement et la lame et fixer le tout par insertion du boulon central.



Serrer l'écrou central (0,2 Nm).

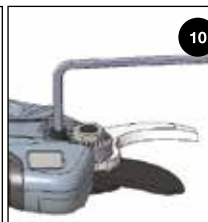

Serrer le dispositif de verrouillage du boulon central.



Remettre la coque et serrer la vis supérieure.



Serrer la vis inférieure.

4. À la fin de l'utilisation

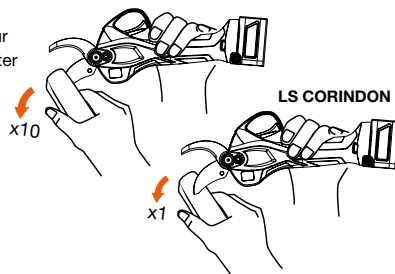
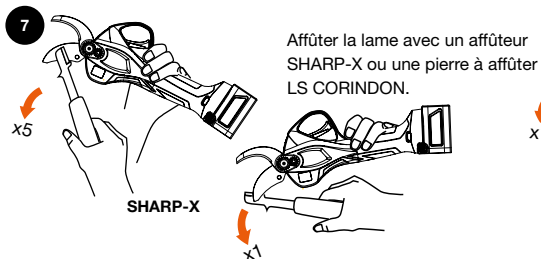
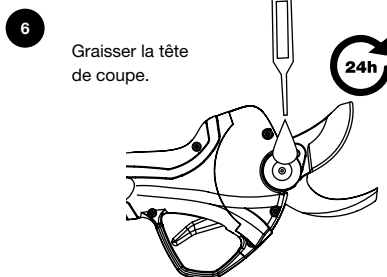
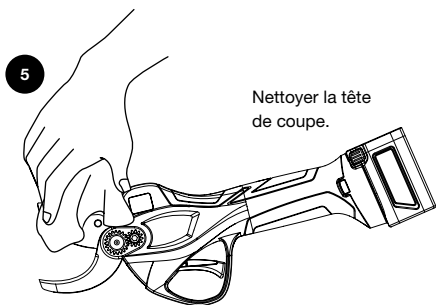
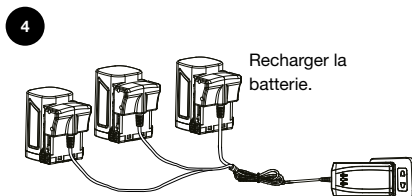
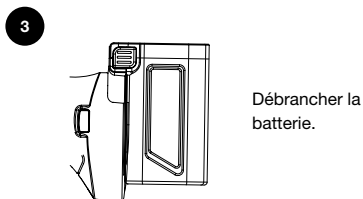
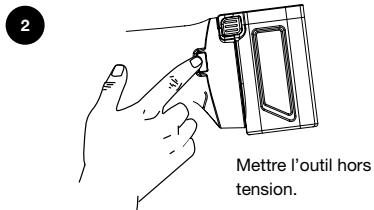
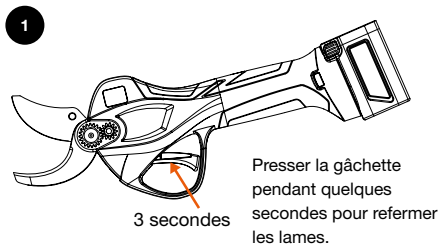

Elenco delle icone con spiegazione

	Precauzioni di sicurezza speciali nell'utilizzo di cesoie elettriche		Indossare occhiali di sicurezza		Apparecchiatura conforme alle norme CE
	Rischio di lesioni: tenere le mani lontane dalla testa di taglio		Indossare guanti di sicurezza		Apparecchiatura conforme agli standard CA del Regno Unito
	Non esporre a pioggia, acqua o umidità		Leggere la guida utente		Strumenti conformi ai requisiti imposti o coperti da normative in Australia e Nuova Zelanda
	Tenere lontano da fonti di calore		Non smaltire insieme ai rifiuti comuni		Sistema di batterie conforme ai requisiti di efficienza della California Energy Commission
	Non utilizzare batterie danneggiate o guaste		Riciclare in conformità alla normativa locale sui rifiuti		

1. Introduzione

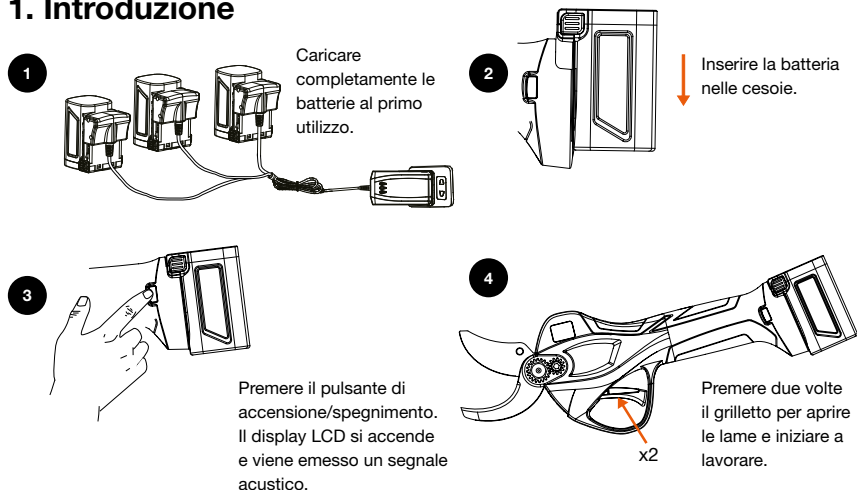

2. Cambiare l'apertura delle lame

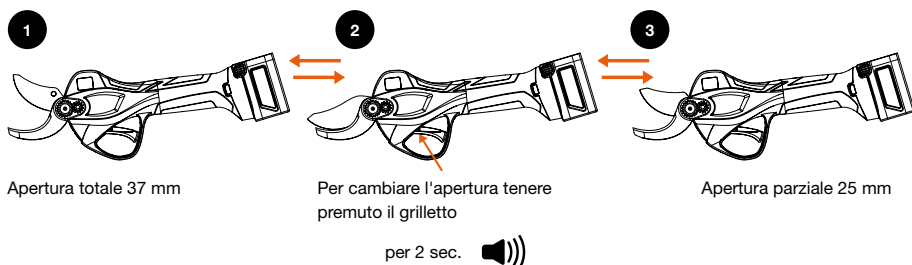

3. Sostituzione della lama



Togliere il coperchio del sistema di azionamento della lama.



Capovolgere l'utensile e svitare la vite di fissaggio del bullone centrale.



Svitare il bullone centrale.



Rimuovere il bullone centrale.



Estrarre il sistema di azionamento e la lama.



Rimuovere la controlama se è necessario sostituirla.

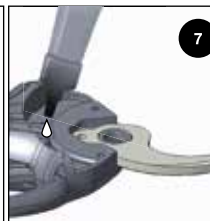

Pulire e ingrassare tutti i componenti, compreso il pignone.

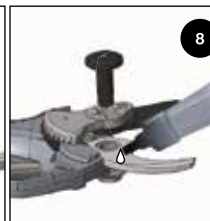

Montare il sistema di azionamento e la lama e fissarli inserendo il bullone centrale.

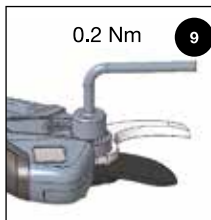

Serrare il bullone centrale (0,2 Nm).



Serrare la vite di fissaggio del bullone centrale.

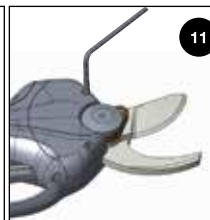

Riposizionare il coperchio e serrare la vite superiore.

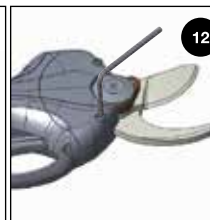

Serrare la vite inferiore.

4. Alla fine della giornata di lavoro

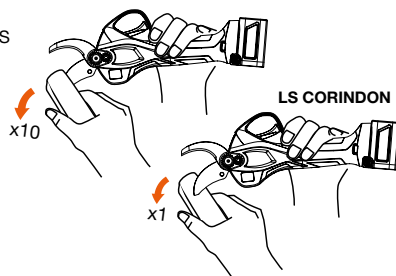
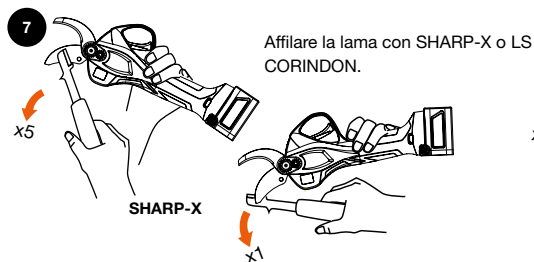
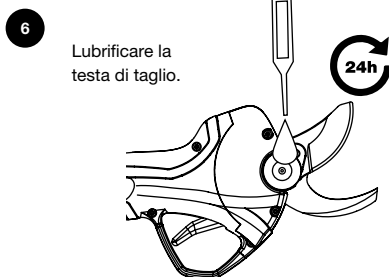
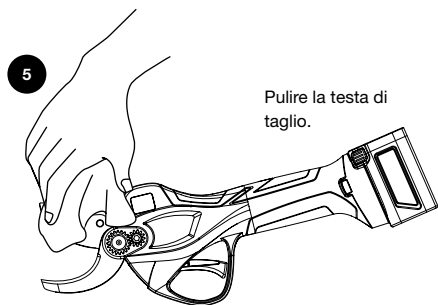
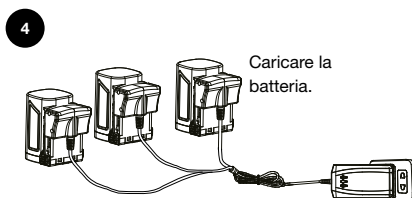
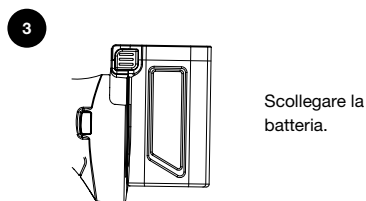
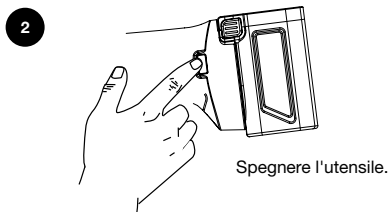
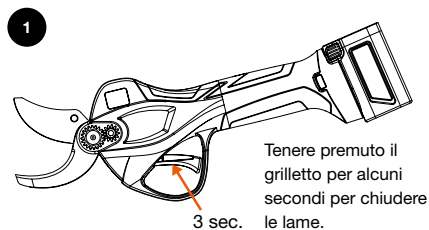

Lijst van pictogrammen met uitleg



Speciale veiligheidsvoorzorgsmaatregelen tijdens het werken met de elektrische snoeischaar



Risico op letsel - houd handen uit de buurt van de snijkop



Niet blootstellen aan regen, water of natte omstandigheden



Uit de buurt van warmtebronnen houden



Geen beschadigde of kapotte batterijen gebruiken



Veiligheidsbril dragen



Veiligheidshandschoenen dragen



Gebruikershandleiding lezen



Niet bij het huishoudelijke afval weggoien



Recyclen in overeenstemming met de plaatselijke afvalregeleaving



Apparatuur die voldoet aan EC-normen



Apparatuur die voldoet aan de Britse CA-normen



Apparatuur die voldoet aan de vereisten die in Australië en Nieuw-Zeeland worden opgelegd of die onder de regelgeving vallen



Batterijsysteem dat voldoet aan de rendementsvereisten van de California Energy Commission

1. Aan de slag

1

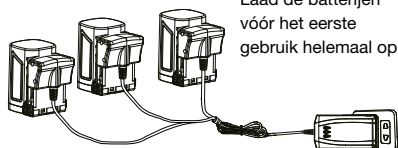

Laad de batterijen vóór het eerste gebruik helemaal op.

2

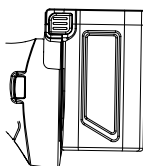

Plaats de batterijen in de snoeischaar.

3

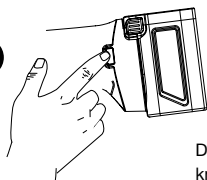

Druk op de aan/uit-knop. Het lcd-display gaat aan en er klinkt één pieptoon.

4

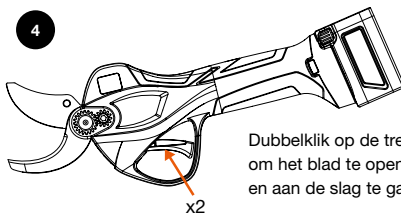

Dubbelklik op de trekker om het blad te openen en aan de slag te gaan.

2. Verwisselen van het blad

1

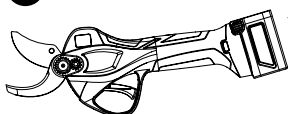

Volledige opening 37 mm

2

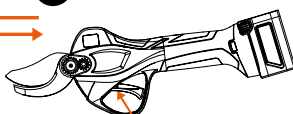

Om de opening te wijzigen, houdt u de trekker

3

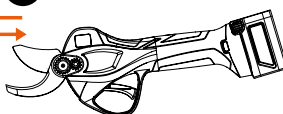

Halve opening 25 mm

gedurende 2 sec. ingedrukt

3. Verwisselen van het blad



Verwijder de beschermkap.



Draai het gereedschap om en schroef de centrale boutvergrendeling los.



Schroef de centrale bout los.



Verwijder de centrale bout.



Verwijder de aandrijving en haal deze van het blad af.



Verwijder het contrames als het nodig is om dit te vervangen.

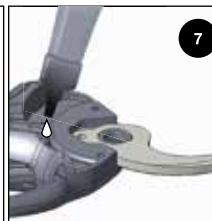

Reinig en smeer alle onderdelen, inclusief de slagpen.

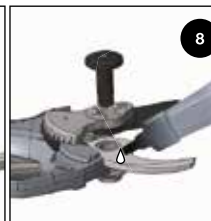

Zet de aandrijving en het blad in elkaar en bevestig het geheel door plaatsing van de centrale bout.



Draai de centrale moer vast (0,2 Nm).

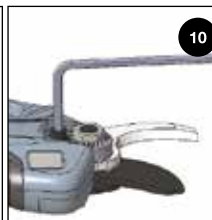

Draai de middenboutvergrendeling vast.

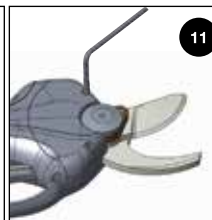

Plaats de afdekking terug en draai de bovenschroef vast.

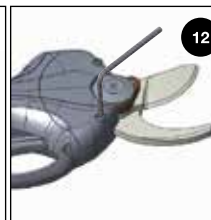

Draai de onderschroef vast.

4. Aan het einde van de werkdag

1

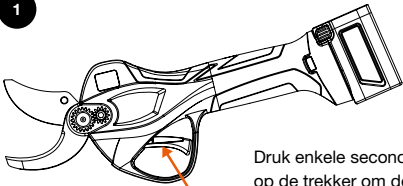

Druk enkele seconden op de trekker om de bladen te sluiten.
3 sec.

2

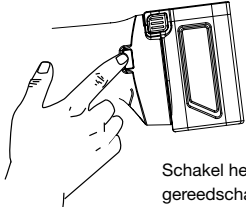

Schakel het gereedschap uit.

3

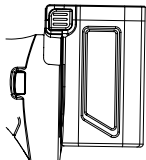

Verwijder de batterij.

4

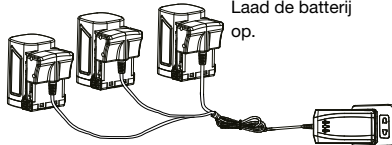

Laad de batterij op.

5

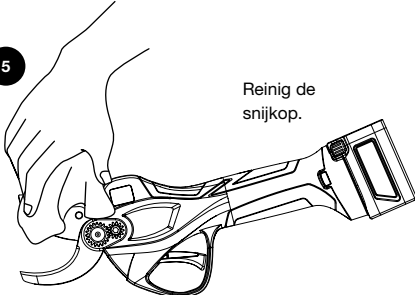

Reinig de snijkop.

6

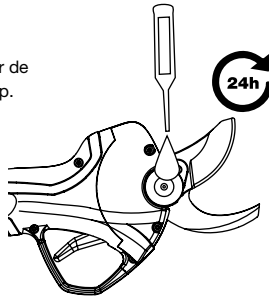

Smeer de snijkop.

24h

7

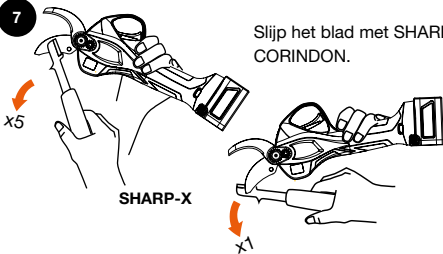

Slijp het blad met SHARP-X of LS CORINDON.

x5

x1

SHARP-X

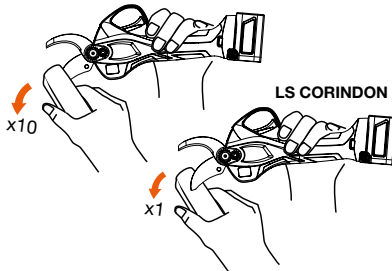

x10

x1

LS CORINDON

Lista ikon z objaśnieniem



Specjalne środki ostrożności podczas pracy z sekatorem elektrycznym



Ryzyko doznania urazów — nie zbliżaj rąk do głowicy tnącej



Nie wystawiać na działanie deszczu, wody lub wilgoci



Nie przechowuj w pobliżu źródeł ciepła



Nie używaj zużytych lub popsutych baterii



Noś okulary ochronne



Noś rękawice ochronne



Przeczytaj instrukcję obsługi



Nie wyrzucaj do odpadów komunalnych



Przełącz do utylizacji zgodnie z lokalnymi przepisami



Urządzenia zgodne ze standardami EC



Urządzenia zgodne z brytyjskimi normami CA



Urządzenie zgodne z wymaganiami nałożonymi lub objętymi przepisami obowiązującymi w Australii i Nowej Zelandii.



System akumulatorów zgodny z wymogami wydajności Kalifornijskiej Komisji Energetycznej

1. Przed przystąpieniem do pracy

1

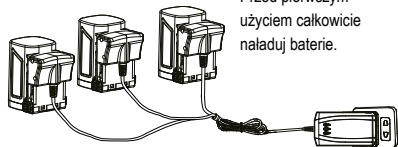

Przed pierwszym użyciem całkowicie naładuj baterie.

2

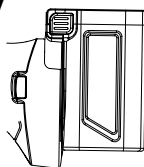

Włóż baterię do sekatora.

3

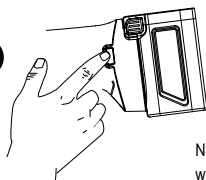

Naciśnij przycisk włącz/wyłącz. Wyświetlacz LCD zaświeci się i rozlegnie się jeden sygnał dźwiękowy.

4

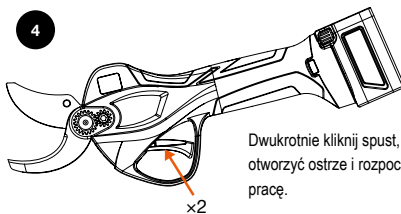

Dwukrotnie kliknij spust, aby otworzyć ostrze i rozpocząć pracę.

2. Zmiana otwarcia ostrza

1

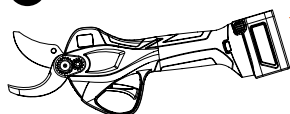

Pełne otwarcie 37 mm

2

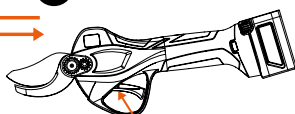

Aby zmienić otwarcie, należy przytrzymać wciśnięty spust

3

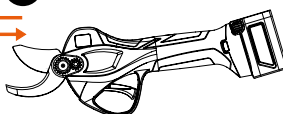

Otwarcie do połowy 25 mm

2 s



3. Wymiana ostrza



Zdejmij osłonę układu napędzającego ostrze.



Obróć narzędzie i wykręć blokadę środkowej śruby.



Wykręć środkową śrubę.



Wymij środkową śrubę z otworu.



Wymij i oddziel układ napędzający od ostrza.



Wymij przeciwostrze, jeżeli wymaga wymiany.

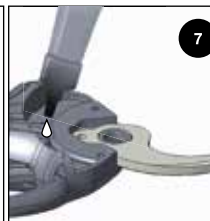

Wyczyść i nasmaruj wszystkie części, również tloczek.

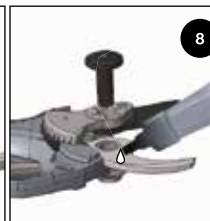

Złóż układ napędzający z ostrzem i przymocuj środkową śrubą.

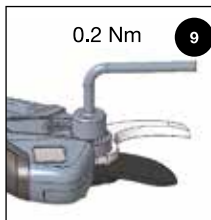

Zakręć środkową nakrętkę (0,2 Nm).

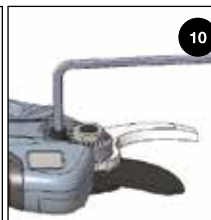

Zakręć blokadę środkowej śruby.

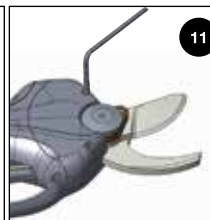

Założ osłonę i zakręć górną śrubę.

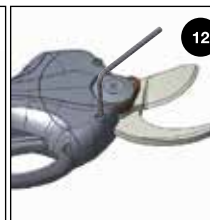

Zakręć dolną śrubę.

4. Na koniec dnia pracy

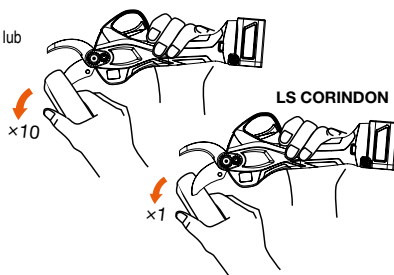
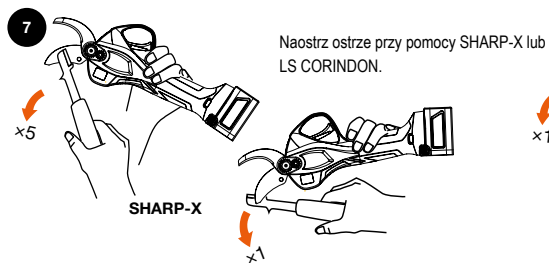
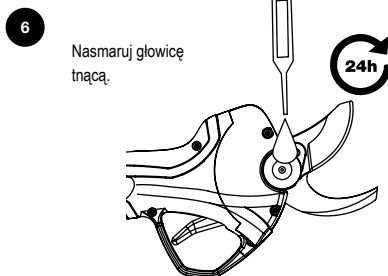
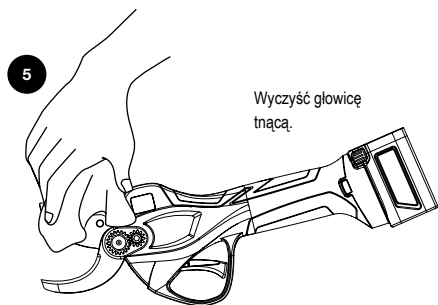
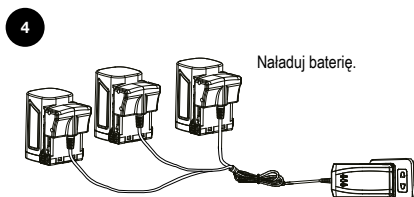
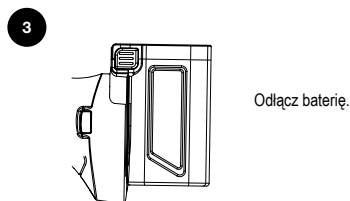
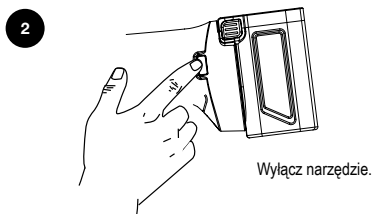
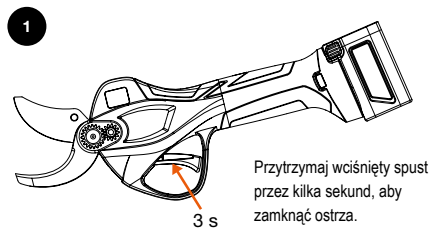

Lista de ícones com explicação



Precauções de segurança especiais no trabalho com tesouras de poda elétricas



Risco de ferimentos – manter as mãos afastadas da cabeça de corte



Não expor a chuva, água ou condições de humidade



Manter afastada de fontes de calor



Não utilizar baterias danificadas ou partidas



Usar óculos de proteção



Usar luvas de proteção



Ler o manual do utilizador



Não eliminar com os resíduos comuns



Reciclar de acordo com as regulamentações locais sobre resíduos



O equipamento cumpre as normas CE



O equipamento cumpre as normas CA do Reino Unido



O equipamento cumpre os requisitos impostos ou abrangidos pelas regulamentações da Austrália e Nova Zelândia



O sistema de bateria cumpre os requisitos de eficiência da California Energy Commission

1. Iniciar

1

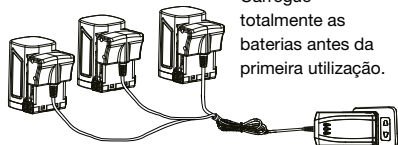

Carregue totalmente as baterias antes da primeira utilização.

2

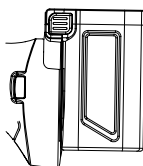

Insira a bateria na tesoura de poda.

3

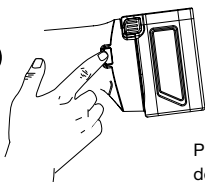

Prima o botão para ligar/desligar. O visor LCD acende-se e é emitido um sinal sonoro.

4

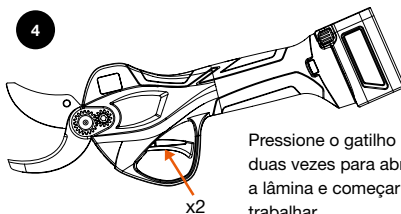

Pressione o gatilho duas vezes para abrir a lâmina e começar a trabalhar.

2. Mudar a abertura da lâmina

1

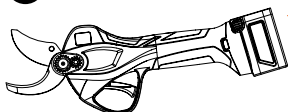

Abertura total 37 mm

2

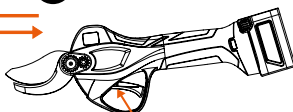

Para mudar a abertura, mantenha o gatilho premido

3

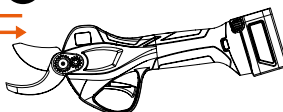

Meia abertura 25 mm

2 seg.

3. Mudar a lâmina



Retire a tampa do sistema de acionamento da lâmina.



Volte a ferramenta ao contrário e desaparafuse o parafuso de bloqueio central.



Desaparafuse o parafuso central.



Retire o parafuso central.



Retire e separe o sistema de acionamento e a lâmina.



Retire a contra-lâmina se for necessário mudá-la.



Limpe e lubrifique todas as peças, incluindo o pinhão.

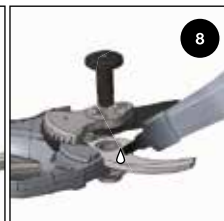

Monte o sistema de acionamento e a lâmina e fixe inserindo o parafuso central.

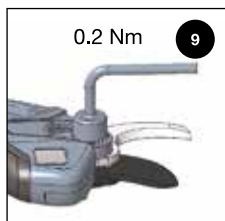

Aperte a porca central (0,2 Nm).



Aperte o parafuso de bloqueio central.

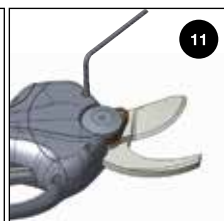

Coloque a tampa de novo e aperte o parafuso superior.



Aperte o parafuso inferior.

4. No fim de um dia de trabalho

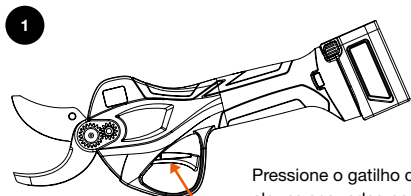

Pressione o gatilho durante alguns segundos para fechar as lâminas.
3 seg.

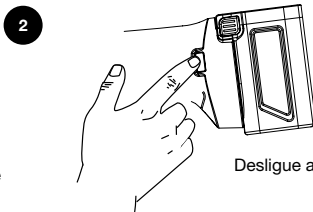

Desligue a ferramenta.

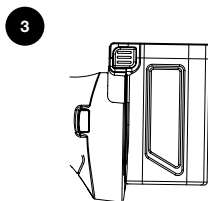

Desligue a bateria.

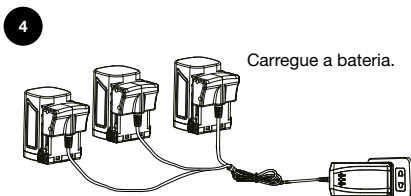

Carregue a bateria.

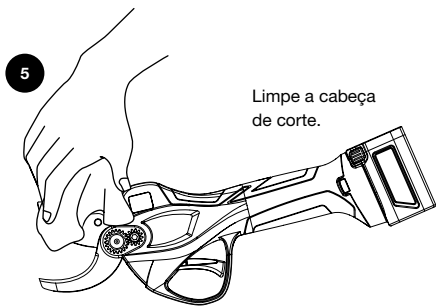

Limpe a cabeça de corte.

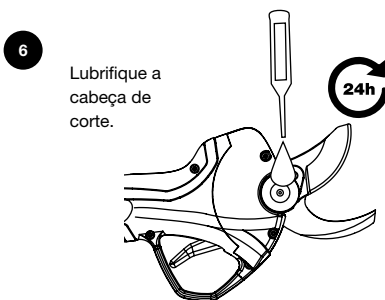

Lubrifique a cabeça de corte.

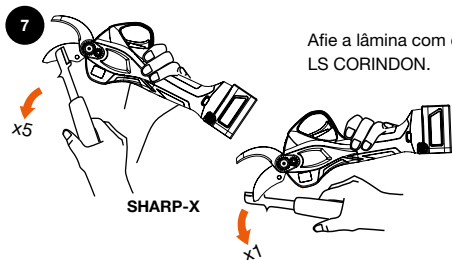

Afie a lâmina com o SHARP-X ou LS CORINDON.

x5

SHARP-X

x1

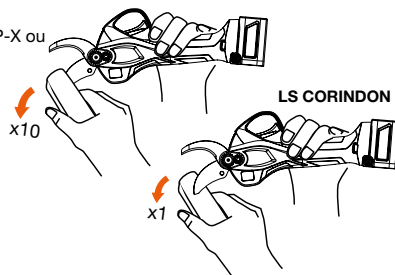

LS CORINDON

x10

x1

Zoznam ikon s vysvetlivkami



Osobitné bezpečnostné opatrenia pri práci s elektrickými záhradníckymi nožnicami



Nebezpečenstvo poranenia – nedotýkajte sa rukami strihacej hlavy



Nevystavujte dažďu, vode ani vlhku



Uchovávajte mimo tepelných zdrojov



Nepoužívajte poškodené alebo prasknuté batérie



Používajte ochranné okuliare



Používajte ochranné rukavice



Prečítajte si návod pre používateľa



Nevyhadzujte do komunálneho odpadu



Recyklujte v súlade s miestnou legislatívou pre odpad



Nástroj spĺňa normy ES



Vybavenie je v súlade s normami CA Spojeného kráľovstva



Vybavenie je v súlade s požiadavkami, ktoré stanovujú alebo zahŕňajú predpisy v Austrálii a na Novom Zélande



Systém akumulátora, ktorý spĺňa požiadavky Kalifornskej komisie pre energetickú účinnosť

1. Začíname

1

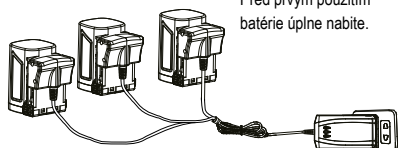

Pred prvým použitím batérie úplne nabite.

2

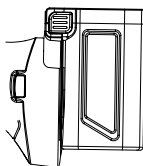

Vložte batériu do záhradníckych nožníc.

3

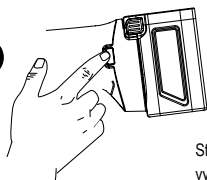

Stlačte tlačidlo on/off (zap./vyp.). LCD displej sa rozsvieti a zaznie jedno pípnutie.

4

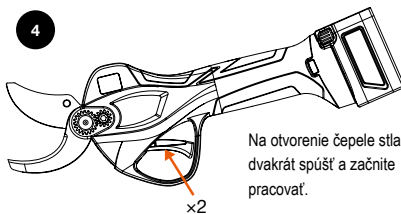

Na otvorenie čepele stlačte dvakrát spúšť a začítne pracovať.

2. Výmena otvoru čepele

1

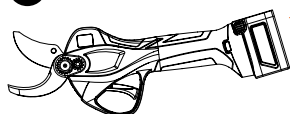

Úplné otvorenie 37 mm

2

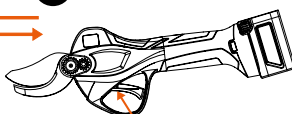

Na zmenu otvorenia podržte spúšť stlačenú

3

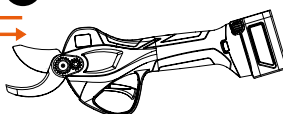

Otvorenie napoly 25 mm

2 s

3. Výmena čepele



1
Odstráňte kryt z hnacej mechaniky čepele.



2
Otočte nástroj a odskrutkujte poistku stredovej skrutky.



3
Odskrutkujte stredovú skrutku.



4
Odstráňte stredovú skrutku.



5
Výberte hnaciu mechaniku a oddelte ju od čepele.



6
Ak je potrebné vymeniť protiahlú čepeľ, odstráňte ju.

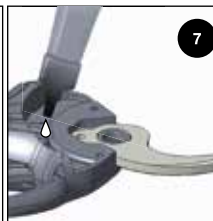

7
Vyčistite a namažte všetky súčiastky vrátane pastorka.

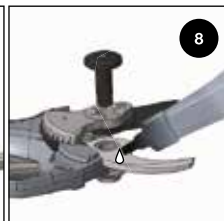

8
Zmontujte hnaciu mechaniku a čepeľ a pripevnite ich vložení stredovej skrutky.



9
0.2 Nm
Utiahnite stredovú maticu (0,2 Nm).



10
Utiahnite poistku stredovej skrutky.

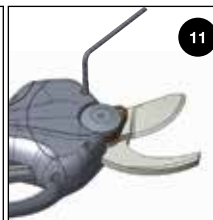

11
Nasadte kryt späť na svoje miesto a utiahnite vrchnú skrutku.



12
Utiahnite spodnú skrutku.

4. Na konci pracovného dňa

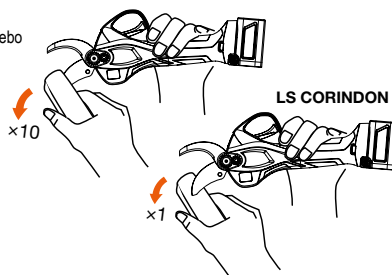
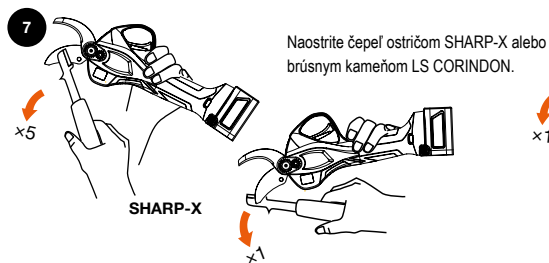
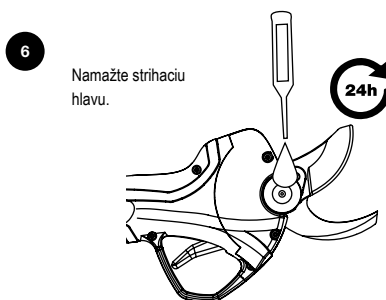
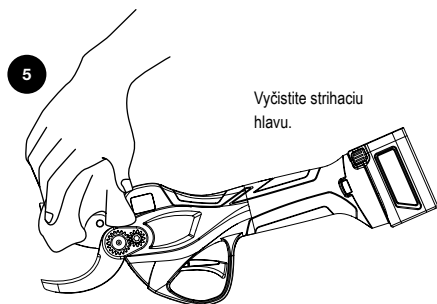
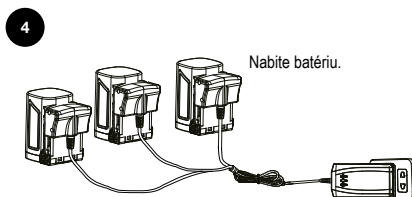
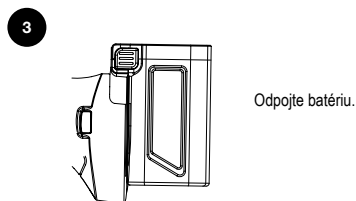
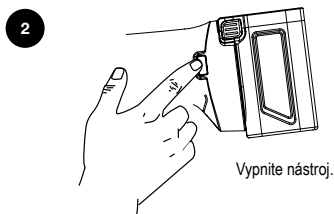
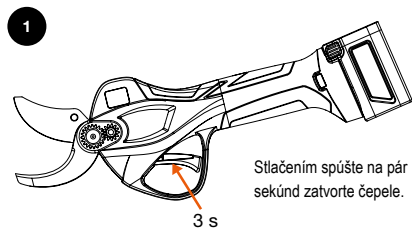

Açıklamalı simgeler listesi



Elektrikli budama makası ile çalışma durumunda özel güvenlik önlemleri



Yaralanma riski – ellerinizi kesici kafadan uzak tutun



Yağmura, suya veya ıslak koşullara maruz bırakmayın



Isı kaynaklarından uzak tutun



Hasarlı veya arızalı aküleri kullanmayın



Koruyucu gözlük kullanın



İş eldiveni kullanın



Kullanım kılavuzunu okuyun



Genel atıklarla birlikte atmayın



Yerel atık yönetmeliğine uygun şekilde geri dönüşümünü sağlayın



EC standartlarına uygun ekipman



UK CA standartlarına uygun ekipman



Avustralya ve Yeni Zelanda'da uygulanan veya düzenlemelerin kapsadığı gereksinimlere uygun ekipman



Kaliforniya Enerji Komisyonu verimlilik gereksinimlerine uygun akü sistemi

1. Başlarken

1

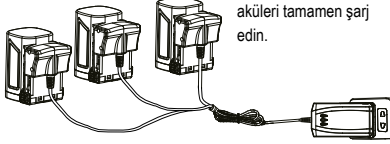

İlk kullanımdan önce aküleri tamamen şarj edin.

2

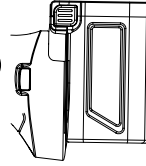

Aküyü budama makasına yerleştirin.

3

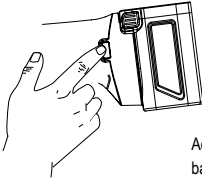

Açma/kapama düğmesine basın. LCD ekran açılır ve bir bip sesi duyulur.

4

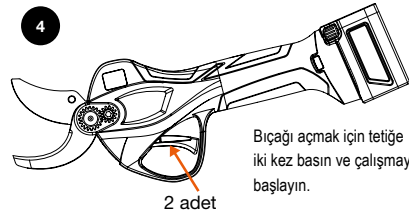

Bıçağı açmak için tetiğe iki kez basın ve çalışmaya başlayın.

2 adet

2. Bıçak açıklığını değiştirme

1

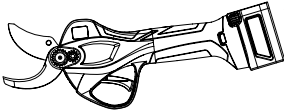

Tam açılma 37 mm

2

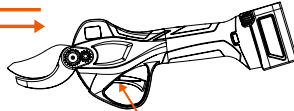

Açılmayı değiştirmek için tetiği basılı tutun

3

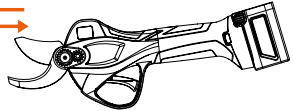

Yarım açıklık 25 mm

2 sn.

3. Bıçağı değiştirme



Bıçak çalışma sisteminin kapağını çıkarın.



Aleti ters çevirin ve merkez cıvata kilit vidasını çıkartın.



Merkez cıvatası vidasını gevşetin.



Merkez cıvata vidasını çıkarın.



Çalıştırma sistemini ve bıçağı çıkarıp ayırın.



Değiştirilmesi gerekirse aksi yöndeki bıçağı çıkarın.



Dişli mil dahil tüm parçaları temizleyin ve yağlayın.

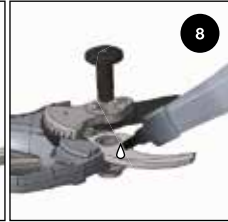

Çalıştırma sistemini ve bıçağı monte edin ve merkez cıvatayı yerleştirerek sabitleyin.



Merkez somunu sıkın (0,2 Nm).

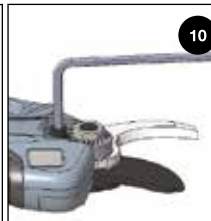

Merkez cıvata kilidini sıkın.



Kapağı geri yerleştirin ve üstteki vidayı sıkın.

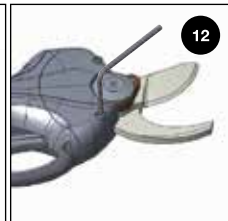

Alltaki vidayı sıkın.

4. İş günü sonunda

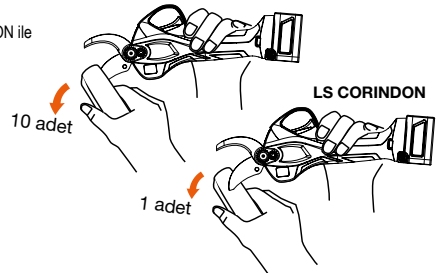
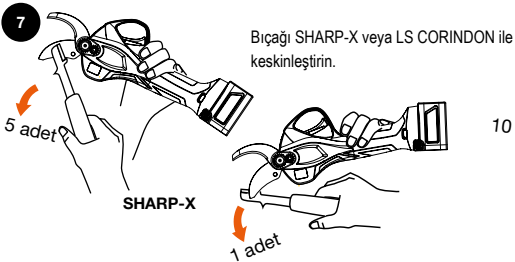
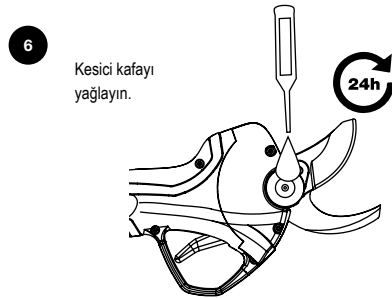
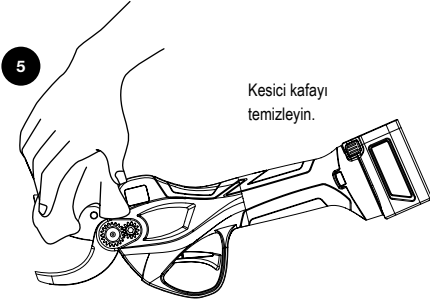
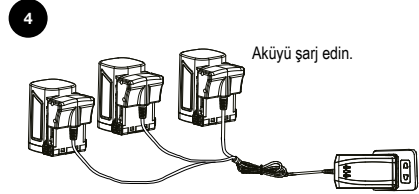
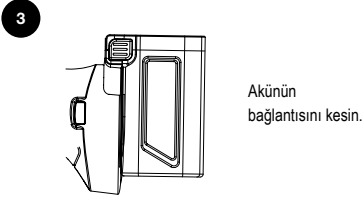
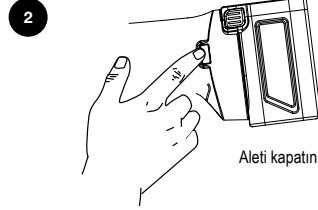
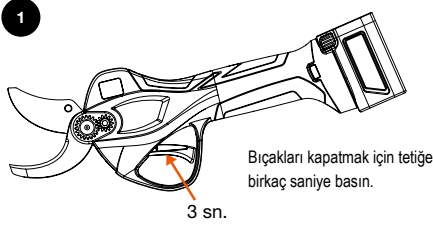

Spisak ikona s objašnjenjem



Posebne mjere opreza pri radu s električnim makazama



Opasnost od povreda - držite ruke dalje od rezne glave



Ne izlagati kiši, vodi ili vlažnim uslovima



Držati dalje od izvora toplote



Nemojte koristiti oštećene ili pokvarene baterije



Nosite zaštitne naočale



Nosite zaštitne rukavice



Pročitajte korisnički vodič



Ne odlagati u opći otpad



Reciklirati u skladu s lokalnim propisima o otpadu



Oprema u skladu s EC standardima



Oprema u skladu s UK CA standardima



Oprema koja je u skladu sa zahtjevima koji su određeni ili obuhvaćeni propisima u Australiji i Novom Zelandu



Sistem baterija koji je u skladu sa zahtjevima o efikasnosti Kalifornijske komisije za energetiku

1. Početak rada

1

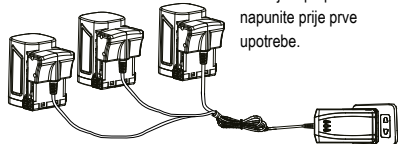

Baterije u potpunosti napunite prije prve upotrebe.

2

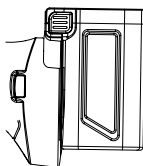

Umetnite bateriju u makaze.

3

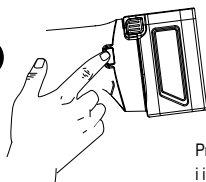

Pritisnite dugme za uključivanje i isključivanje. Uključuje se LCD ekran i oglašava se jedan zvučni signal.

4

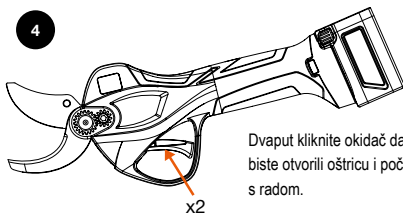

Dvaput kliknite okidač da biste otvorili oštricu i počeli s radom.

2. Promijenite otvor oštrice

1

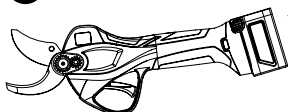

Puni otvor 37 mm

2

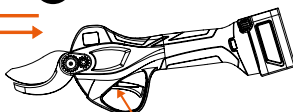

Za promjenu otvora držite pritisnut okidač

3

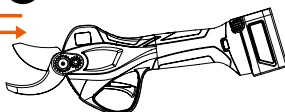

Otvaranje napola 25 mm

2 sek.

3. Promijenite oštricu



Uklonite poklopac sistema za pokretanje oštrice.



Okrenite alat i odšarafite zaključavanje centralnog vijka.



Ođvornite centralni vijak.



Uklonite centralni vijak.



Izvadite i odvojite sistem za pokretanje i oštricu.



Uklonite suprotnu oštricu ako ju je potrebno promijeniti.



Očistite i podmažite sve dijelove uključujući zupčanik.

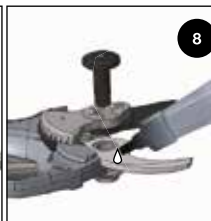

Sastavite sistem za pokretanje i oštricu i namjestite umetanjem centralnog vijka.

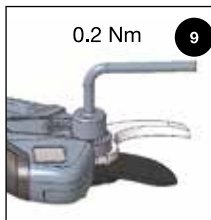

Zategnite centralnu maticu (0,2 Nm).



Zategnite zaključavanje centralnog vijka.

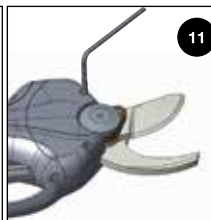

Vratite poklopac i zategnite gornji šaraf.

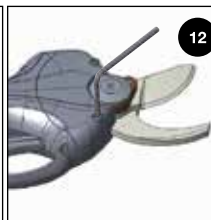

Zategnite donji šaraf.

4. Na kraju radnog dana

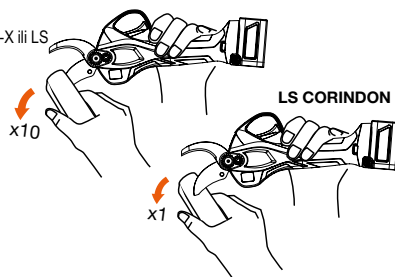
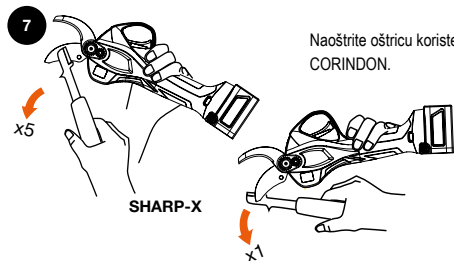
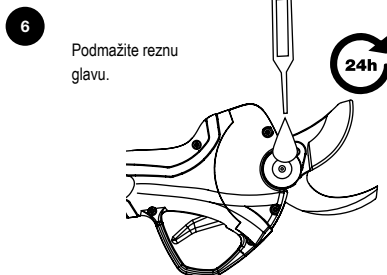
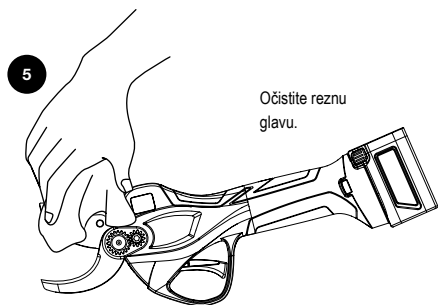
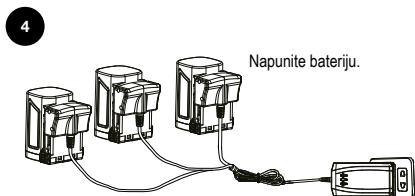
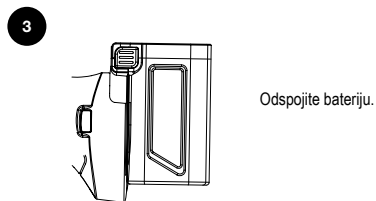
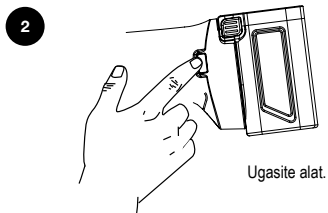
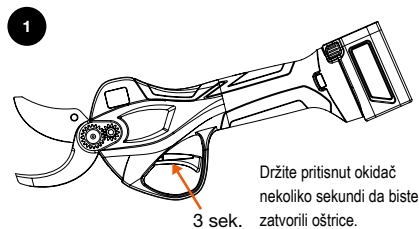

Liste over ikoner, med forklaring



Specielle sikkerhedsforanstaltninger under arbejde med elektriske beskæresakse



Risiko for tilskadekomst – hold hænderne på afstand af skærehovedet



Må ikke udsættes for regn, vand eller våde forhold



Holdes på afstand af varmekilder



Anvend ikke beskadigede eller ødelagte batterier



Bær sikkerhedsbriller



Bær sikkerhedshandsker



Læs brugervejledningen



Må ikke bortskaffes sammen med almindeligt husholdningsaffald



Bortskaffes i henhold til de lokale bestemmelser for affald



Udstyr, der overholder EC-standarderne



Udstyr, der overholder UK CA-standarderne



Udstyr, der opfylder de krav, der er indført ved eller dækket af forordninger i Australien og New Zealand



Batterisystem, der overholder Californiens energikommissions krav til effektivitet

1. Kom godt i gang

1

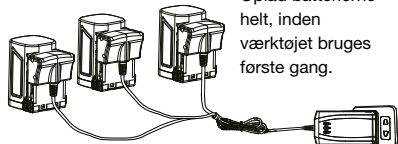

Oplad batterierne helt, inden værktøjet bruges første gang.

2

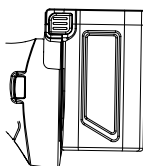

Sæt batteriet i beskæresaksen.

3

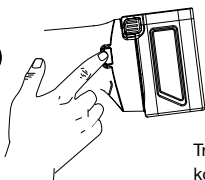

Tryk på tænd/sluk-kontakten. LCD-displayet tændes, og der lyder ét bip.

4

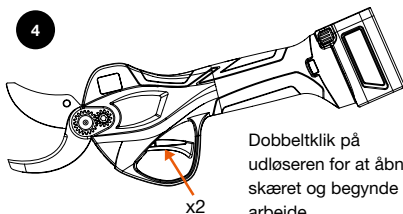

Dobbelklik på udløseren for at åbne skæret og begynde at arbejde.

2. Ændring af skærets åbningsvinkel

1

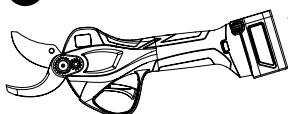

Fuld åbning 37 mm

2

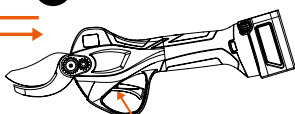

Hold udløseren nede for at ændre åbningsvinklen

3



Halv åbning 25 mm

2 sek.

3. Udskiftning af skæret



Fjern afskærmningen til skærets drivsystem.



Vend værktøjet om, og skru låsebolten af.



Skru låsebolten af.



Fjern låsebolten.



Tag drivsystemet og skæret ud, og adskil delene.



Fjern modskæret, hvis det skal udskiftes.

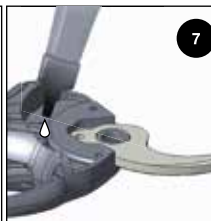

Rengør og smør alle delene, inklusive tanddrevet.

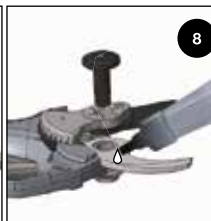

Saml drivsystemet og skæret, og fastgør begge dele ved at isætte låsebolten.

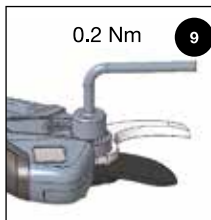

Spænd samlebolen (0,2 Nm).



Spænd låsebolten.

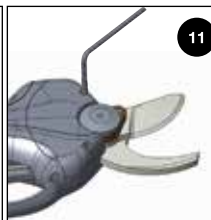

Sæt afdækningen på igen, og spænd den øverste skrue.

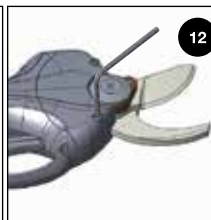

Spænd den nederste skrue.

4. Når arbejdsdagen er slut

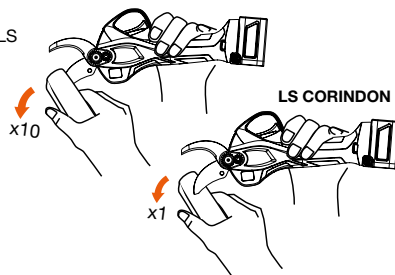
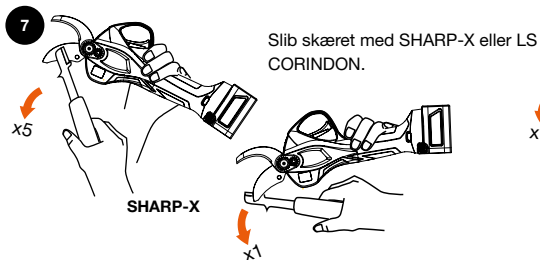
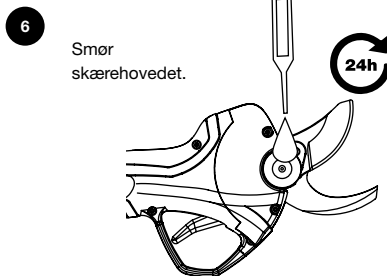
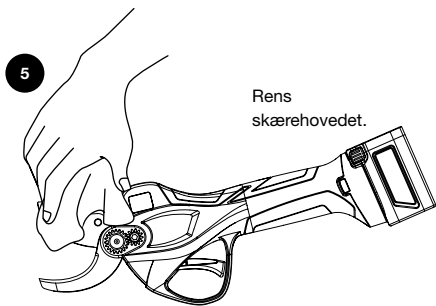
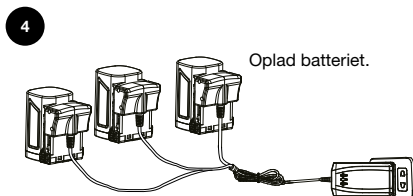
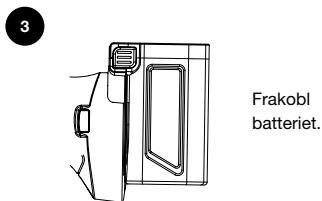
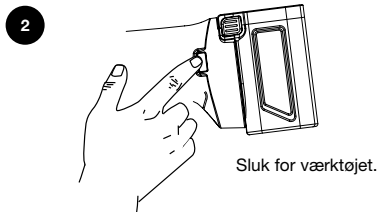
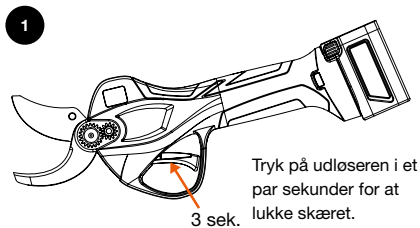

Kuvakeluettelo ja selitykset



Erityiset turvallisuusvaroitimet sähkökäyttöisten oksasaksien kanssa työskenneltäessä



Loukkaantumisaava – pidä kädet loitolla leikkauspästä



Älä altista sateelle, vedelle tai märille olosuhteille.



Pidä erossa lämmönlähteistä



Älä käytä vaurioituneita tai rikkoutuneita akkuja



Käytä suojalaseja



Käytä suojakäsineitä



Lue tämä käyttöohje



Ei saa hävittää kotitalousjätteen mukana



Kierrätä paikallisen jätelainsäädännön määräysten mukaisesti



Laitte on EU-standardien vaatimustenmukainen



Ison-Britannian CA-standardien mukaiset laitteet



Laitteet, jotka täyttävät Australiassa ja Uudessa-Seelannissa asetettujen vaatimusten mukaiset vaatimukset



Kalifornian energiakomission tehokkuusvaatimusten mukainen akkujärjestelmä

1. Ennen kuin aloitat työkalun käytön

1

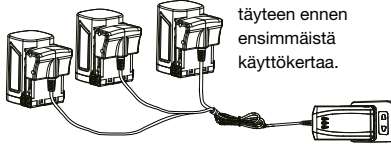

Lataa akut täyteen ennen ensimmäistä käyttökertaa.

2

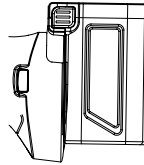

Aseta akku oksaksiin.

3

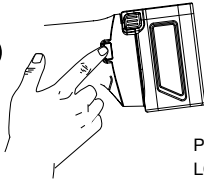

Paina virtapainiketta. LCD-näyttö syttyy ja kuuluu yksi äänimerkki.

4

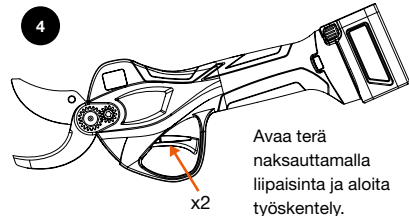

Avaa terä naksauttamalla liipaisinta ja aloita työskentely.

2. Terän aukon muuttaminen

1

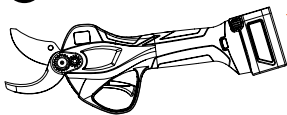

Koko aukko 37 mm

2

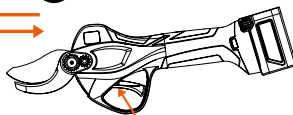

Voit muuttaa aukkoa pitämällä liipaisinta painettuna.

3

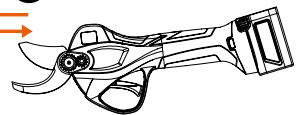

Puoliaukko 25 mm

2 s

3. Teränvaihto



Irrota kansi terästä.



Käännä työkalu toisinpäin ja avaa keskipultin lukitus.



Avaa keskipultti.



Irrota keskipultti.



Irrota osat sekä terä ja erota ne toisistaan.



Irrota alaterä, jos se täytyy vaihtaa.

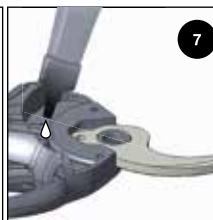

Puhdista ja rasvaa kaikki osat, myös hammasvaihte.

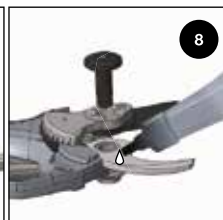

Kokoa osat sekä terä ja kiinnitä asettamalla keskipultti paikalleen.

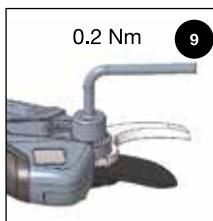

Kiristä keskimutteri (0,2 Nm).



Kiristä keskipultin lukitus.

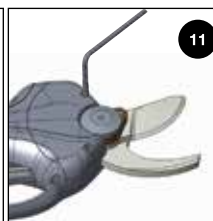

Aseta kansi paikalleen ja kiristä yläruuvi.



Kiristä alaruuvi.

4. Työpäivän loppuksi

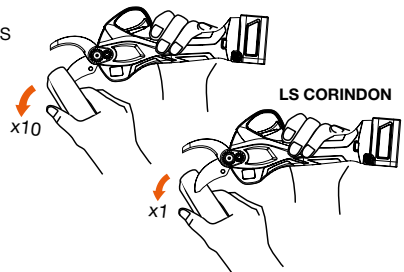
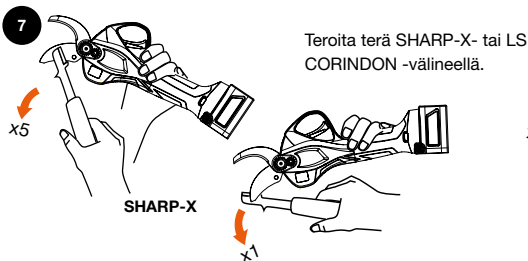
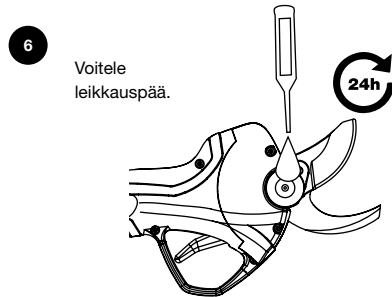
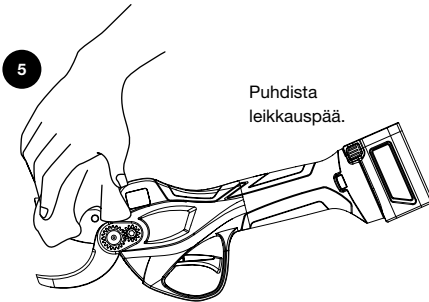
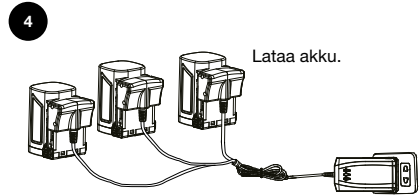
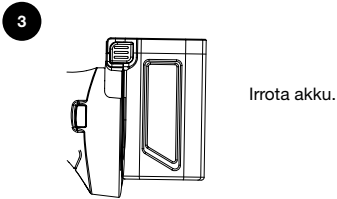
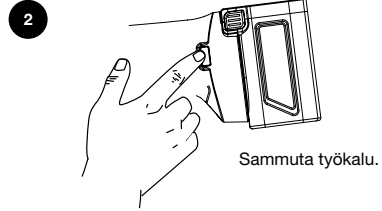
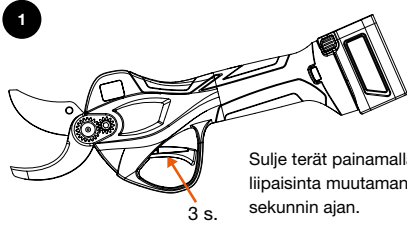

Ikonok és magyarázatuk



Az akkumulátoros metszőolló különleges óvintézkedéseket igényel



Sérülésveszély – tartsa a kezét távol a vágófejtől



Óvja az esőtől, a víztől és a nedves környezettől.



Hőforrástól távol tartandó



Sérült vagy hibás akkumulátorral ne használja



Viseljen védőszemüveget



Viseljen munkavédelmi kesztyűt



Olvassa el a használati útmutatót



Ne helyezze háztartási hulladékba



Hasznosítsa újra a helyi előírásoknak megfelelően



A berendezés megfelel az EK szabványoknak



A berendezés megfelel az UK CA szabványoknak



A berendezés megfelel az ausztráliai és új-zélandi rendeletek követelményeinek



Az akkumulátorrendszer megfelel a California Energy Commission hatékonysági követelményeinek

1. Első lépések

1

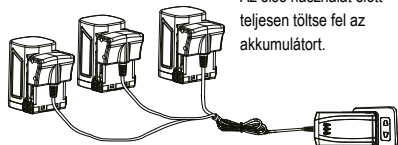

Az első használat előtt teljesen töltse fel az akkumulátort.

2

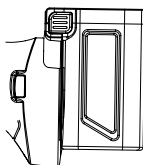

Helyezze be az akkumulátort a metszőollóba.

3

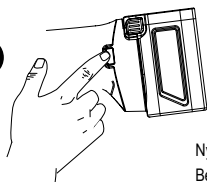

Nyomja meg a BE/KI gombot. Bekapcsol az LCD-kijelző, és megszólal egy hangjelzés.

4

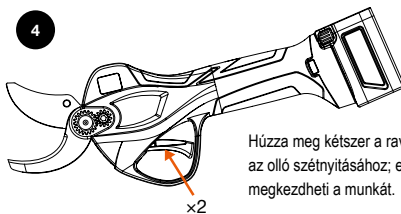

Húzza meg kétszer a ravaszt az olló szétnyitásához; ezután megkezdheti a munkát.

2. A pengenyitás módosítása

1



Teljes nyitás 37 mm

2

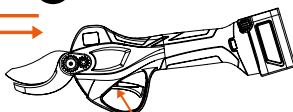

A nyitás módosításához tartsa nyomva a ravaszt

2 mp

3



Félnyitás 25 mm

3. A penge cseréje



1 Vegye le a mozgatórendszer burkolatát.



2 Fordítsa meg a szerszámot és hajtsa ki a központi csavar rögzítőcsavarját.



3 Hajtsa ki a központi csavart.



4 Vegye ki a központi csavart.



5 Vegye ki és szedje szét a hajtórészt és a pengét.



6 Ha az ellenpenge cserére szorul, távolítsa el.



7 Tisztítsa meg és olajozzon meg minden alkatrészt, a fogaskereket is beleértve.

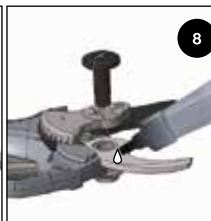

8 Szerelje össze a hajtórészt és a pengét, majd a központi csavar behelyezésével rögzítse.

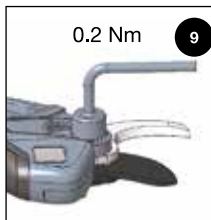

9 Húzza meg a központi anyát (0,2 Nm).



10 Húzza meg a központi csavar rögzítőcsavarját.

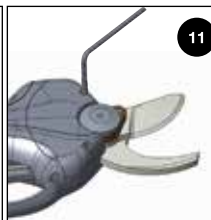

11 Helyezze vissza a burkolatot, és húzza meg a felső csavart.

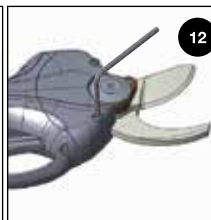

12 Húzza meg az alsó csavart.

4. A munka végeztével

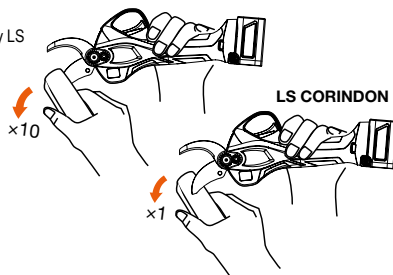
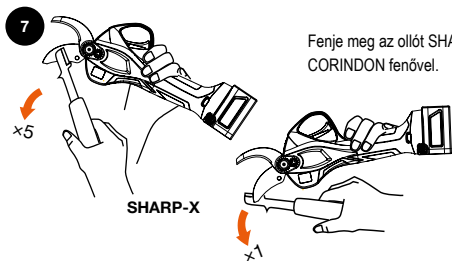
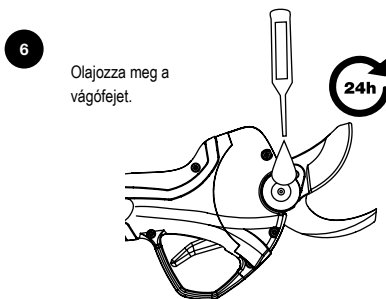
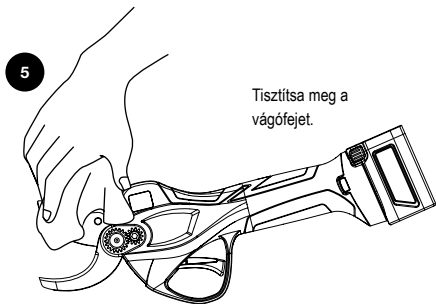
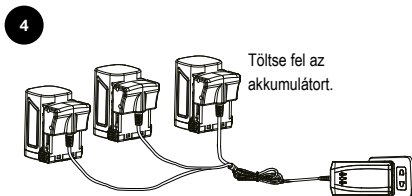
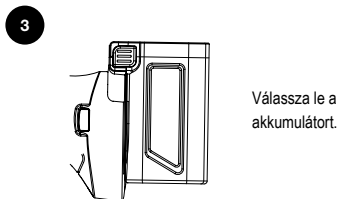
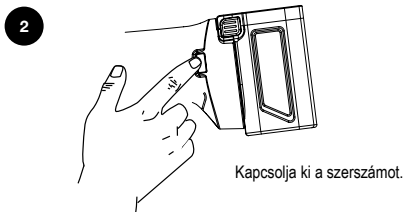
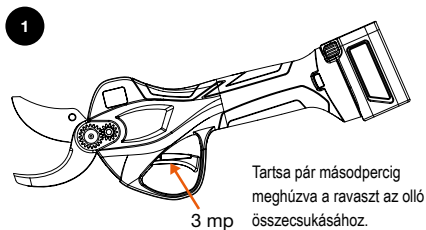

Liste over ikoner med forklaring

- | | | | | | |
|---|--|---|---|---|--|
|  | Spesielle forholdsregler ved arbeid med elektrisk beskjæringsaks |  | Bruk vernebriller |  | Utstyret er i overensstemmelse med EC-standardene |
|  | Risiko for personskade – hold hendene borte fra skjærehodet |  | Bruk vernehansker |  | Utstyr som samsvarer med UK CA-standarder |
|  | Må ikke utsettes for regn, vann eller våte forhold |  | Les bruksanvisningen |  | Utstyr som overholder gjeldende krav eller er underlagt forskrifter i Australia og New Zealand |
|  | Holdes borte fra varmekilder |  | Skal ikke kastes som restavfall |  | Batterisystem som oppfyller kravene til energikommisjonen i California |
|  | Ikke bruk skadede eller ødelagte batterier |  | Gjenvinnes i henhold til lokal lovgivning | | |

1. Kom i gang

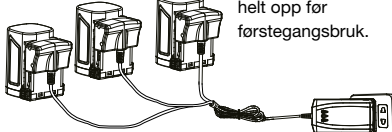
- 

Lad batteriene helt opp for førstegangsbruk.
- 

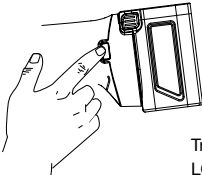
Sett batteriet inn i beskjæringsaksaksen.
- 

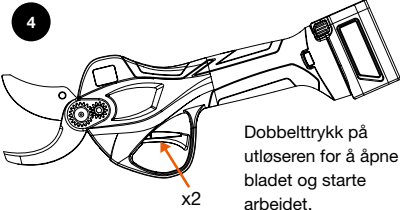
Trykk på av/på-knappen. LCD-displayet slås på, og et pipesignal høres.
- 

Dobbeltrykk på utløseren for å åpne bladet og starte arbeidet.

2. Endre bladåpningen

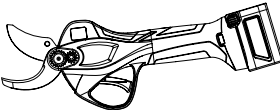
- 

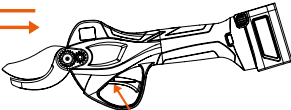
Full åpning 37 mm
 - 

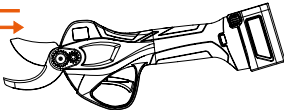
Hold inne utløseren for å endre åpningen
 - 

Halv åpning 25 mm
- 2 sek. 

3. Skifte bladet



Fjern dekeleiet over bladdriftssystemet.



Snu verktøyet og skru løs låsen på den midtre bolten.



Skru løs den midtre bolten.



Fjern den midtre bolten.



Ta ut og demonter driftssystemet og bladet.



Fjern motskjæret hvis det skal skiftes.

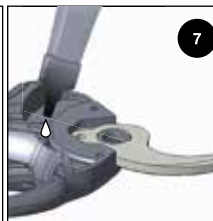

Rengjør og smør alle deler, inkludert svingtappen.

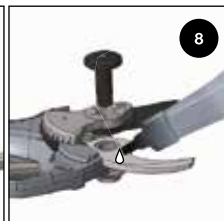

Monter driftssystemet og bladet, og fest det ved å sette inn den midtre bolten.



Trekk til den midtre mutteren (0,2 Nm).



Trekk til den midtre boltlåsen.

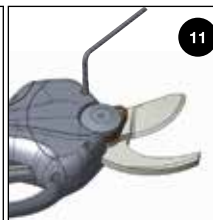

Sett på dekeleiet igjen, og trekk til den øvre skruen.



Trekk til den nedre skruen.

4. Etter endt arbeidsdag

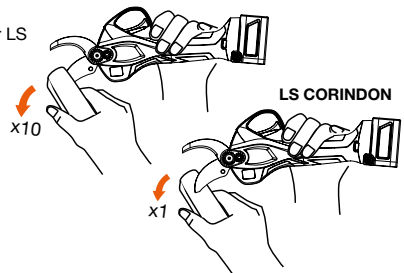
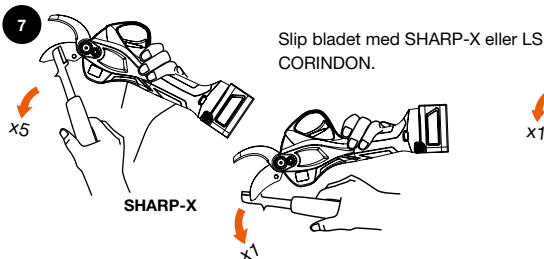
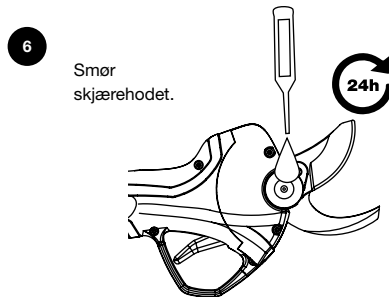
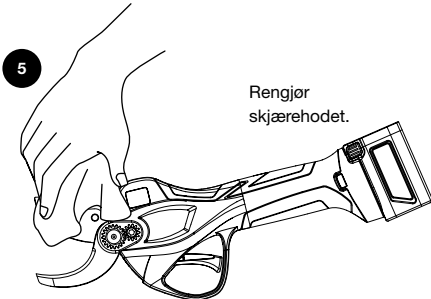
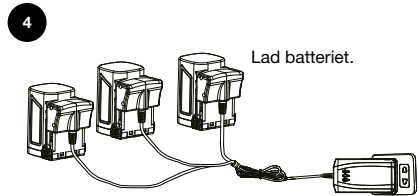
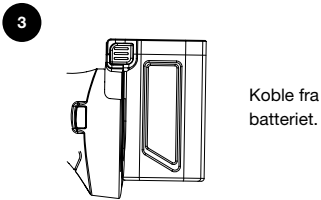
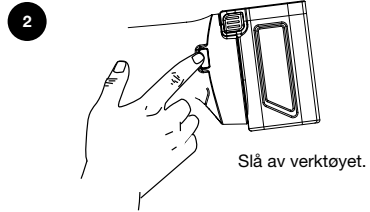
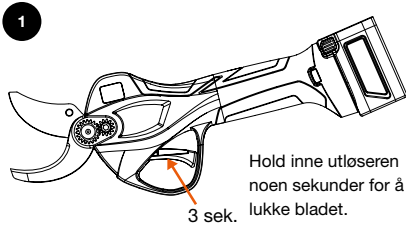

Список значков с пояснениями



Соблюдайте особые меры предосторожности при работе с электрическими секаторами.



Опасность травмирования — держите руки на удалении от режущей головки.



Не подвергайте изделие воздействию дождя, воды или влаги.



Держите изделие подальше от источников тепла.



Не используйте повреждённые или неисправные аккумуляторы.



Используйте защитные очки.



Используйте защитные перчатки.



Изучите руководство пользователя.



Не утилизируйте вместе с общими бытовыми отходами.



Утилизируйте в соответствии с местными правилами утилизации отходов.



Оборудование, соответствующее стандартам ЕС



Оборудование, соответствующее стандартам Великобритании и Канады



Оборудование, соответствующее требованиям законодательства Австралии и Новой Зеландии



Аккумуляторная система, соответствующая требованиям Калифорнийской энергетической комиссии в отношении энергоэффективности

1. Начало работы

1

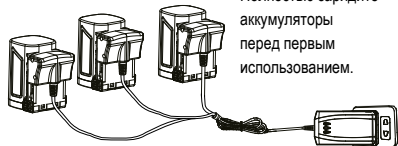

Полностью зарядите аккумуляторы перед первым использованием.

2

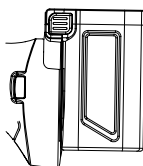

Вставьте аккумулятор в секатор.

3

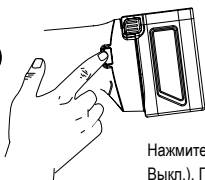

Нажмите кнопку On/Off (Вкл./Выкл.). При этом включается ЖК-дисплей и подаётся один звуковой сигнал.

4

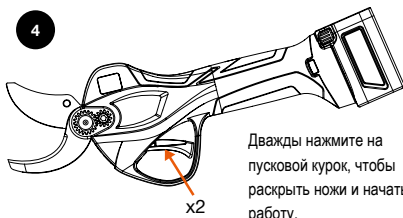

Дважды нажмите на пусковой курок, чтобы раскрыть ножи и начать работу.

2. Изменение степени раскрытия ножей

1

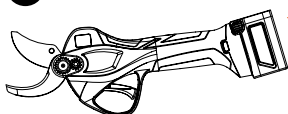

Полное раскрытие — 37 мм

2

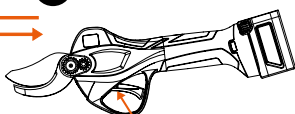

Для изменения степени раскрытия ножей нажмите и удерживайте пусковой курок в течение

2 секунд.

3

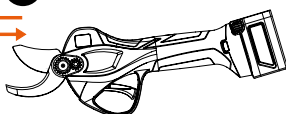

Полураскрытие — 25 мм

3. Замена ножей



Снимите крышку системы привода ножей.



Переверните инструмент и отверните центральный болт-фиксатор.



Отверните центральный болт.



Снимите центральный болт.



Снимите и отсоедините систему привода и нож.



Снимите контр-нож, если требуется его замена.

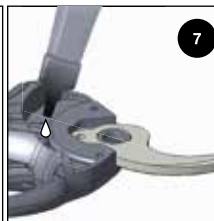

Очистите и смажьте консистентной смазкой все детали, включая шестерню.

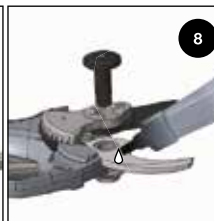

Установите систему привода и нож и зафиксируйте их, вставив центральный болт.

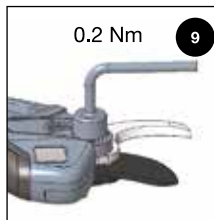

Затяните центральную гайку (0,2 Нм).

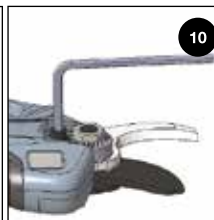

Затяните центральный болт-фиксатор.

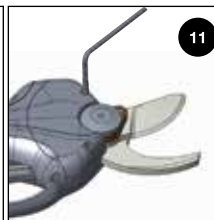

Установите на место крышку и затяните верхний винт.



Затяните нижний винт.

4. В конце рабочего дня

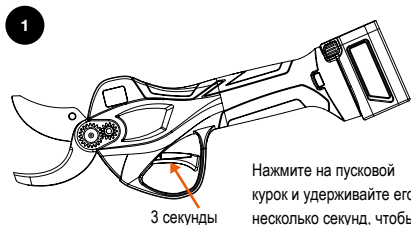

3 секунды

Нажмите на пусковой курок и удерживайте его несколько секунд, чтобы закрыть ножи.

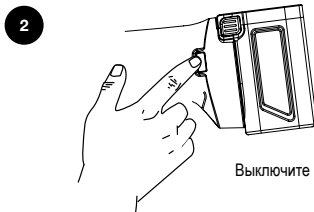

Выключите инструмент.

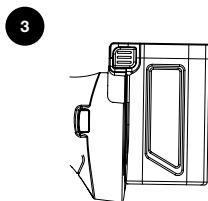

Отсоедините аккумулятор.

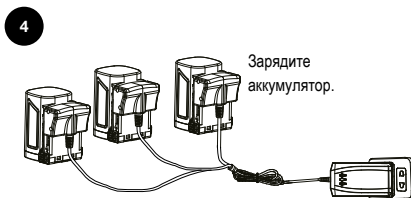

Зарядите аккумулятор.

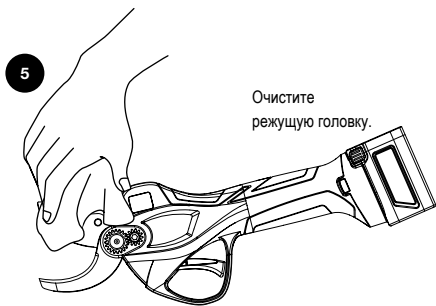

Очистите режущую головку.

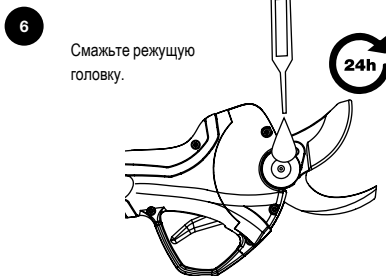

Смажьте режущую головку.

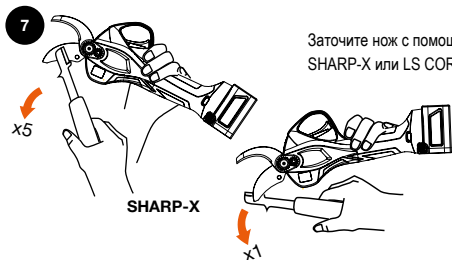

SHARP-X

Заточите нож с помощью инструмента SHARP-X или LS CORINDON.

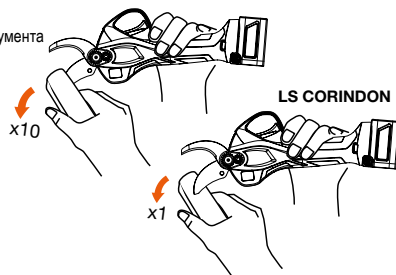

LS CORINDON

Lista pictogramelor cu explicații



Măsuri speciale de siguranță când lucrați cu foarfeca electrică



Risc de accidentare – țineți mâinile la distanță de capul de tăiat



Nu expuneți produsul la ploaie, apă sau condiții de umezeală



Țineți departe de sursele de căldură



Nu utilizați baterii deteriorate sau sparte



Purtați ochelari de protecție



Purtați mănuși de protecție



Citiți ghidul de utilizare



Nu aruncați cu deșeurile generale



Reciclați în conformitate cu reglementările locale privind deșeurile



Echipament în conformitate cu standardele CE



Echipament în conformitate cu standardele CA din Regatul Unit



Echipament în conformitate cu cerințele impuse sau acoperite de regulamentele din Australia și Noua Zeelandă



Sistem de baterii în conformitate cu cerințele de eficiență ale Comisiei pentru energie din California

1. Pornirea

1

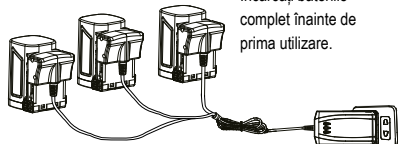

Încărcați bateriile complet înainte de prima utilizare.

2

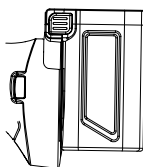

Introduceți bateriile în foarfecă.

3

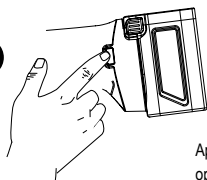

Apăsați butonul de pornire/oprire. Afișajul LCD se aprinde și se aude un sunet.

4

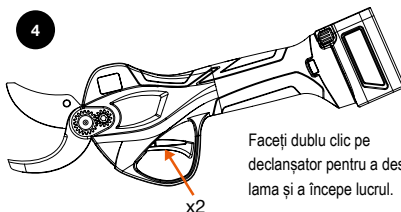

Faceți dublu clic pe declanșator pentru a deschide lama și a începe lucrul.

2. Schimba și deschiderea lamei

1

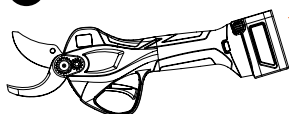

Deschidere completă 37 mm

2

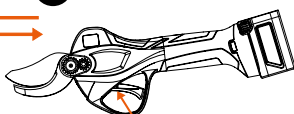

Pentru a schimba deschiderea, țineți apăsat declanșatorul

3

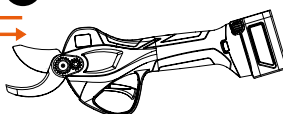

Semi-deschidere 25 mm

2 sec.

3. Schimbați lama



1
Scoateți capacul sistemului de acționare a lamei.



2
Rotiți instrumentul și deșurubați opritorul șurubului central.



3
Desfaceți șurubul central.



4
Scoateți șurubul central.



5
Scoateți și separați sistemul de acționare și lama.



6
Scoateți contra-lama dacă este necesar să o înlocuiți.



7
Curățați și lubrifiați toate piesele, inclusiv pinionul.

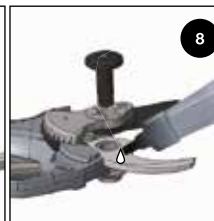

8
Asamblați sistemul de acționare și lama și fixați prin introducerea șurubului central.

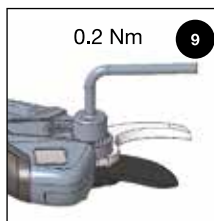

9
0.2 Nm
Strângeți șurubul central (0,2 Nm).

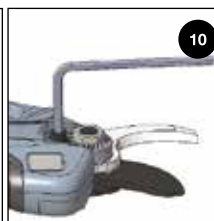

10
Strângeți opritorul șurubului central.

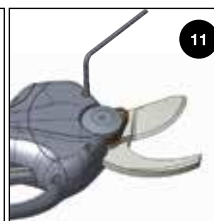

11
Puneți la loc capacul și strângeți șurubul superior.

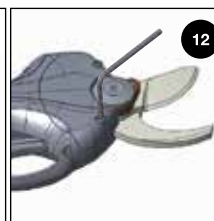

12
Strângeți șurubul inferior.

4. La sfârșitul unei zile de lucru

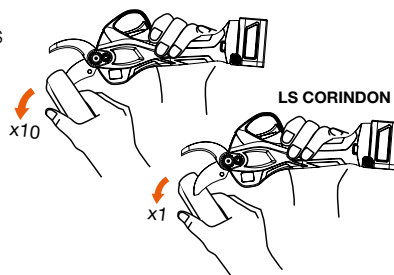
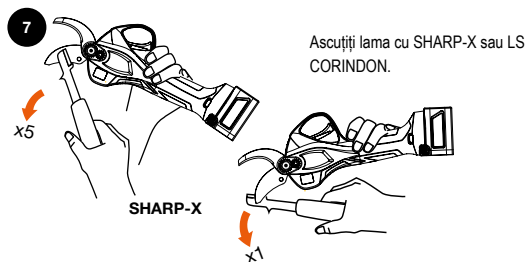
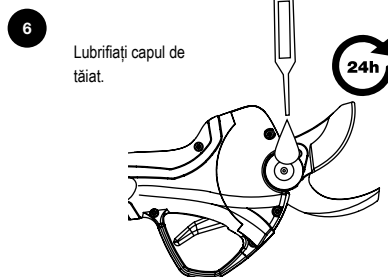
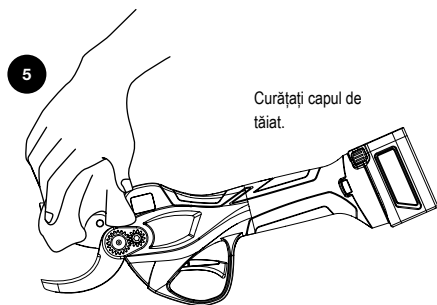
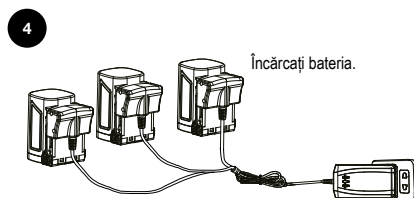
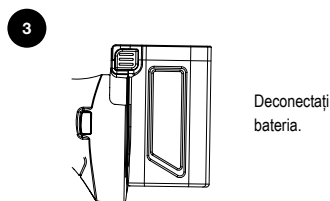
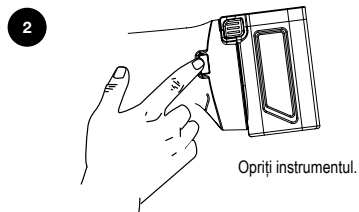
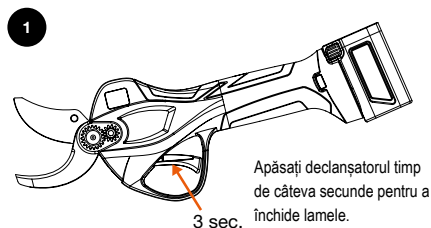

Seznam ikon z razlago



Posebni varnostni ukrepi pri delu z električnimi vrtnarskimi škarjami



Možnost poškodbe – roke držite stran od rezalne glave



Ne izpostavljajte dežju, vodi ali mokrim pogojem



Ne približujte virom toplote



Ne uporabljajte okvarjenih ali poškodovanih baterij



Nosite zaščitna očala



Nosite zaščitne rokavice



Preberite uporabniški priročnik



Ne odlagajte med splošne odpadke



Reciklirajte v skladu z lokalnimi predpisi glede odpadkov



Oprema, skladna s standardi ES



Oprema, skladna s standardi UK CA



Oprema, ki izpolnjuje zahteve, določene ali zajete v predpisih v Avstraliji in na Novi Zelandiji



Baterijski sistem v skladu z zahtevami Kalifornijske komisije za energetsko učinkovitost

1. Uvod

1

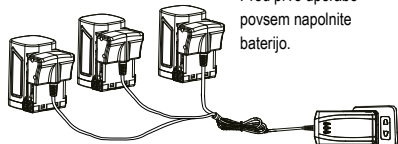

Pred prvo uporabo povsem napolnite baterijo.

2

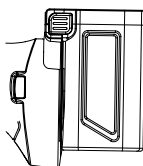

Vstavite baterijo v vrtnarske škarje.

3

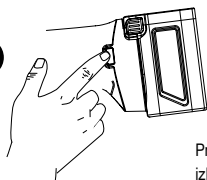

Pritisnite gumb za vklop/izklop. LCD zaslona se vklopi in sliši se en pisk.

4

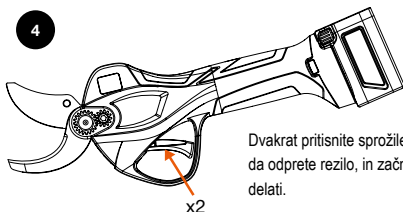

Dvakrat pritisnite sprožilec, da odprete rezilo, in začnete delati.

2. Spremenite odprtino rezila

1

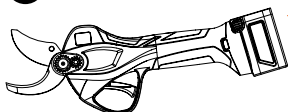

Polna odprtina 37 mm

2

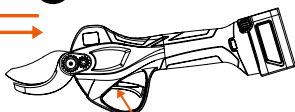

Če želite spremeniti odprtino, držite sprožilec

3

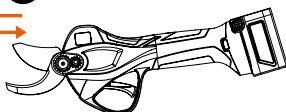

Polovično odpiranje 25 mm

2 s

3. Zamenjava rezila



1
Odstranite pokrov pogonskega sistema rezila.



2
Obrnite orodje naokrog in odvijte zaklep osrednjega vijaka.



3
Odvijte osrednji vijak.



4
Odstranite osrednji vijak.



5
Odstranite in ločite pogonski sistem in rezilo.



6
Odstranite nasprotno rezilo, če ga je treba zamenjati.

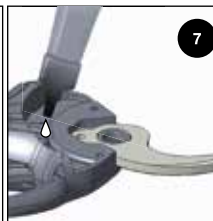

7
Očistite in naoljite vse dele, vključno z zobnikom.

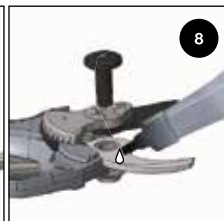

8
Sestavite pogonski sistem in rezilo ter ju fiksirajte tako, da vstavite osrednji vijak.



9
0.2 Nm
Privijte osrednjo matico (0,2 Nm).



10
Privijte zaklep osrednjega vijaka.

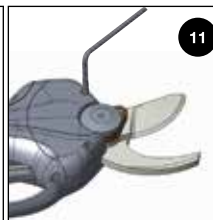

11
Namestite pokrov in privijte zgornji vijak.



12
Privijte spodnji vijak.

4. Ob koncu delovnega dne

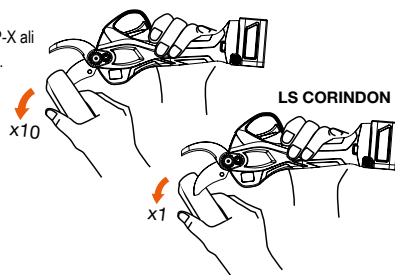
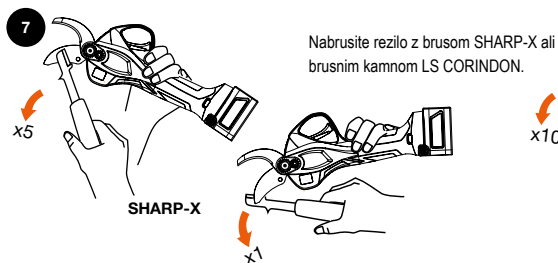
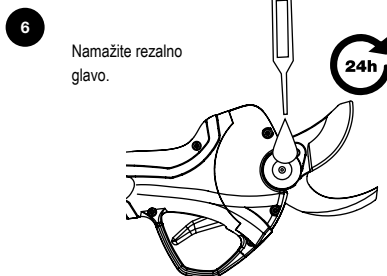
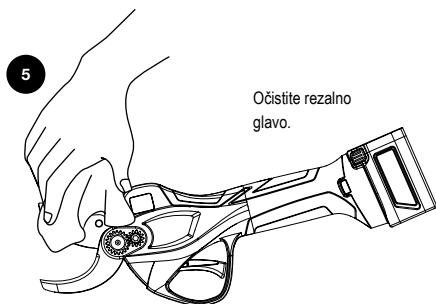
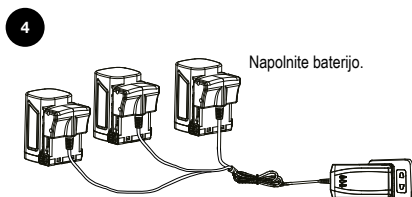
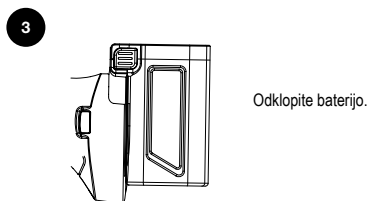
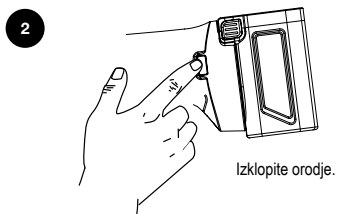
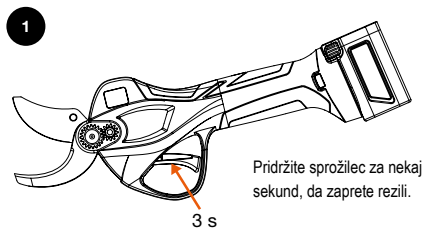

Lista över ikoner med förklaring



Särskilda försiktighetsåtgärder vid arbete med elektrisk sekator



Använd skyddsglasögon



Produkten uppfyller kraven i EU-standarder



Skaderisk – håll händerna på avstånd från klipp huvudet



Använd skyddshandskar



Utrustning som uppfyller UK CA-standarder



Utsätt inte produkten för regn, vatten eller våta förhållanden



Läs bruksanvisningen



Utrustning som uppfyller de krav som införts genom eller beskrivs i bestämmelser i Australien och Nya Zeeland



Utsätt inte produkten för värmekällor



Släng inte i vanliga hushållssopor



Batterisystem som uppfyller California Energy Commissions effektivitetskrav



Använd inte skadade eller trasiga batterier



Återvinn i enlighet med lokala avfallsregler

1. Komma igång

1

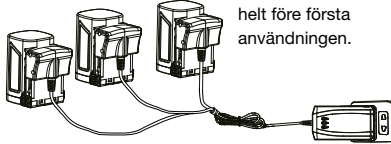

Ladda batterierna helt före första användningen.

2

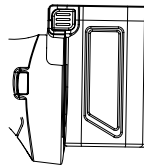

Sätt i batteriet i sekatorn.

3

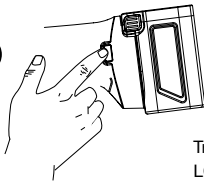

Tryck på strömknappen. LCD-displayen tänds och ett pip hörs.

4

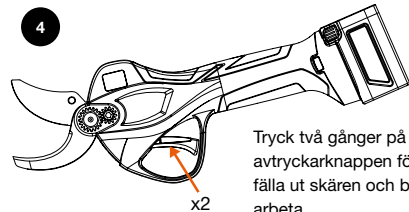

Tryck två gånger på avtryckarknappen för att fälla ut skären och börja arbeta.

2. Ändra utfällningsgraden för skären

1



Helt utfällda 37 mm

2

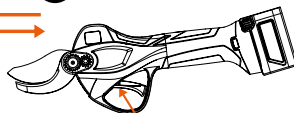

Ändra utfällningsgrad genom att hålla avtryckaren intryckt i

3

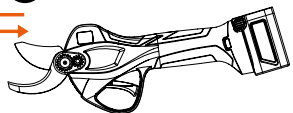

Halvt utfällda 25 mm

2 sek.

3. Byt ut skären



Ta bort skyddet från skärdrivsystemet.



Vänd på verktyget och lossa centrumbultslåset.



Lossa centrumbulten.



Ta bort centrumbulten.



Ta ut och ta isär drivsystemet och skären.



Ta bort motskären om det behöver bytas ut.



Rengör och smörj alla delar, inklusive drevaxeln.

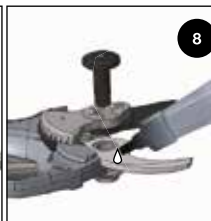

Sätt tillbaka drivsystemet och skären och fixera allt genom att sätta tillbaka centrumbulten.

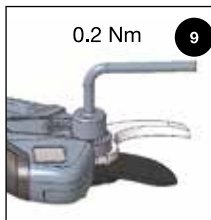

Dra åt centrumbulten (0,2 Nm).



Dra åt centrumbultlåset.

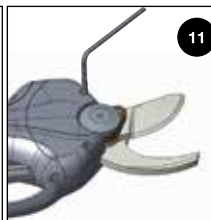

Sätt tillbaka skyddet och dra åt den övre skruven.

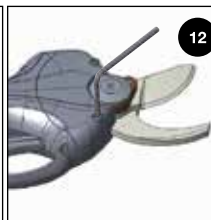

Dra åt den undre skruven.

4. När arbetet är klart

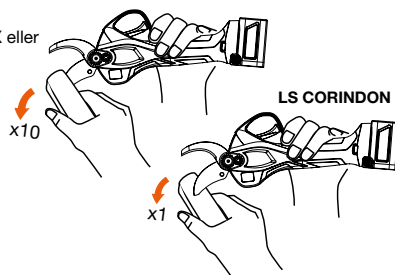
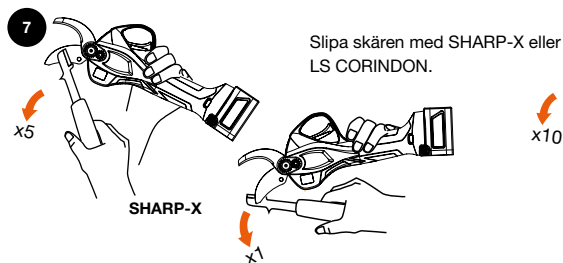
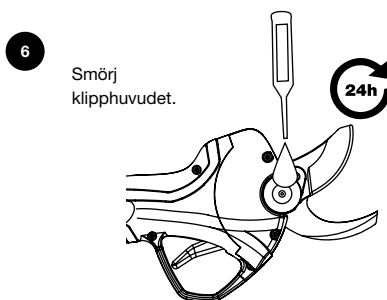
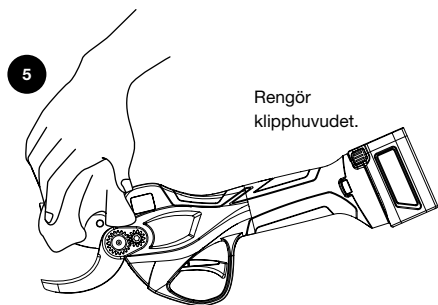
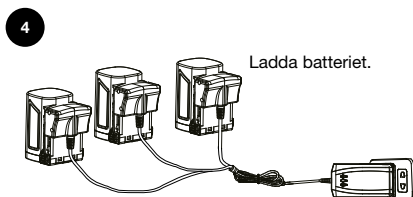
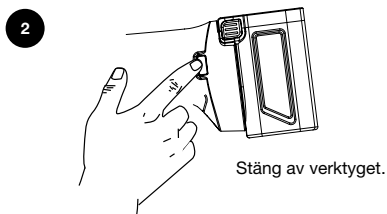
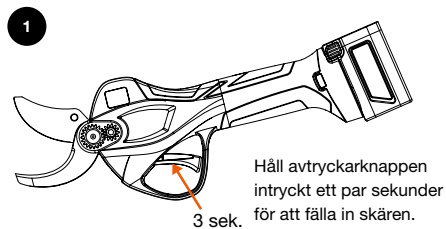

(ENG) CE DECLARATION OF CONFORMITY
 (FRA) DÉCLARATION DE CONFORMITÉ CE
 (SPA) DECLARACIÓN DE CONFORMIDAD DE LA CE
 (POR) DECLARAÇÃO DE CONFORMIDADE EC
 (ITA) DICHIARAZIONE DI CONFORMITA' CE
 (DEU) EG-KONFORMITÄTSERKLÄRUNG
 (NLD) EG- VERKLARING VAN OVEREENSTEMMING
 (POL) EC DEKLARACJA ZGODNOŚCI
 (SWE) CE DEKLARATION

(DAN) EF-VERENSTEMMELSESEKRLÆRING
 (NOR) ECSAMSVERKLARING
 (FIN) EY-VAATIMUSTENMIKUISUUSVAKUUTUS
 (RUS) ДЕКЛАРАЦИЯ О СООТВЕТСТВИИ ЕС
 (TUR) CE STANDARDIZASYON BEYANI
 (CES) PROHLÁŠENÍ O SHODĚ
 (SLK) PREHLÁSENIE O ZHODE
 (ELL) ΗΛΟΣΗ ΣΥΜΜΟΡΦΩΣΗΣ ΜΕ ΕΕ
 (HUN) CE - MEGFELELŐSÉGI NYILATKOZAT

(ENG): Hereby declares that: / The device:
 (FRA): Déclare par la présente que: / L'appareil:
 (SPA): Declaro que: / El aparato:
 (POR): Vimos por este meio declarar: / O aparelho:
 (ITA): Con la presente dichiaro che: / Dispositivo:
 (DEU): Hiermit wird erklärt, dass: / Die folgenden Erzeugnisse:
 (NLD): Hierbij verklaart dat: / Het apparaat:
 (POL): Niniejszym oświadczam, że: / Urządzenia:
 (SWE): Härmed deklaras att: / Enheten:

(DAN): Erklærer herved at: / enheten:
 (NOR): Erklærer herved at: / enheten:
 (FIN): Vakuutamme täten: / Että tuote:
 (RUS): Настоящим заявляем, что: / Устройство:
 (TUR): Beyan ederiz ki: / Cihaz:
 (CES): Níže prohlašujeme, že: / Výrobek:
 (SLK): Týmto prehlasujeme, že: / Výrobok:
 (ELL): Δηλώνω ότι: / Η συσκευή:
 (HUN): Ez kijelenti, hogy: / Az eszköz:

(ENG) Type(s): (FRA) Type(s): (SPA) Tipo(s): (POR) Tipo: (ITA) Tipo: (DEU) Type(s): (NLD) Typen: (POL) Typ: (SWE) Typ: (DAN) Typ: (NOR) Typ: (FIN) Tuotppi: (RUS) Тип: (TUR) Tip: (CES) Typ: (SLK) Typ: (ELL) Τύπος: (HUN) Típus:	BCL25IB	(ENG) Product: (FRA) Produit: (SPA) Producto: (POR) Produto: (ITA) Prodotto: (DEU) Produkt: (NLD) Product: (POL) Produkt: (SWE) Produkten: (DAN) Produktet: (NOR) Produktet: (FIN) Tuotteen: (RUS) Изделие: (TUR) Ürün: (CES) Výrobek: (SLK) Výrobok: (ELL) Προϊόν: (HUN) Termék:	Electric secateurs Secateur électrique Tijeras de podar electronicas Tesoura de poda eletrônica Forbici elettroniche Elektrische rebsechere Elektrische snoeischaar Sekator elektroniczny Elektronisk trädgårdssax Elektronisk beskæresaks Elektronisk grensaks Elektroniset puutarhasokset Электрические секаторы Elektronik sekator Elektronické zahradnicke nuzky Elektronické zahradnicke noznice Ηλεκτρονική ψαλίδα Elektronmos metszoolok	(ENG) Year: (FRA) Année: (SPA) Año: (POR) Ano: (ITA) Anno: (DEU) Baujahr: (NLD) Jaar: (POL) Rok: (SWE) År: (DAN) År: (NOR) År: (FIN) Vuosi: (RUS) Год: (TUR) Sene: (CES) Rok: (SLK) Rok: (ELL) Χρόνος: (HUN) Év:	2021
--	----------------	--	--	---	-------------

(ENG) Was manufactured in conformity with the provisions in the:
 (FRA) A été fabriqué en conformité avec les dispositions des:
 (SPA) Está fabricada según las disposiciones de:
 (POR) Foi fabricado em conformidade com os pressupostos:
 (ITA) Prodotto in conformità con le disposizioni:
 (DEU) In Übereinstimmung mit den Bestimmungen der:
 (NLD) Is vervaardigd in overeenstemming met de bepalingen in de:
 (POL) Został wyprodukowany zgodnie z przepisami
 (SWE) Producerats enligt bestämmelserna i följande direktiv:

(DAN) Produisert i samsvar med bestemmelsene i:
 (NOR) Produisert i samsvar med bestemmelsene i:
 (FIN) On valmistettu noudattaen säännöksiä:
 (RUS) Было произведено в соответствии с положениями:
 (TUR) Aşağıdaki Standartlara uygun üretilmiştir:
 (CES) Byl vyroben ve shodě s předpisy:
 (SLK) Bol vyrobený v zhode s predpismi:
 (ELL) Κατασκευάστηκε σύμφωνα με τις διατάξεις του:
 (HUN) A következő rendelkezéseknek megfeleleően gyártották:

Directive 2006/42/EC, 2014/30/EU, 2014/35/EU

(ENG) Person authorized to compile the technical file: (FRA) Personne autorisée à constituer le dossier technique: (SPA) Persona facultada para elaborar el expediente técnico: (POR) Pessoa autorizada para elaborar o dossier técnico: (ITA) Persona autorizzata a compilare la pratica tecnica: (DEU) Bevollmächtigte(r) zum Zusammenstellen technischer Unterlagen: (NLD) Persoon die is gemachtigd het technisch dossier samen te stellen: (POL) Osoba odpowiedzialna za zestawianie pliku technicznego: (SWE) Person som är behörig att sammanställa den tekniska dokumentationen: (DAN) Person bemyndiget til at udarbejde tekniske beskrivelser: (NOR) Autorisert person for utarbeidelse av den tekniske filen: (FIN) Henkilö on valtuutettu kokoomaan teknisen tiedoston: (TUR) Teknik dosyayı düzenlemeye yetkili kişi: (RUS) Лицо, уполномоченное на составление технической документации: (CES) Autorizovaná osoba pro sestavení technického spisu: (SLK) Osoba zodpovedná za vypracovanie technickej dokumentácie: (ELL) Άτομο εξουσιοδοτημένο να καταρτίσει τον τεχνικό φάκελο: (HUN) A műszaki dokumentáció összeállítására feljogosított személy:	<p>Sergio García Quality manager</p>  <p>Date: August 4th, 2021</p>
---	---

(ENG) CE DECLARATION OF CONFORMITY
(FRA) DÉCLARATION DE CONFORMITÉ CE
(SPA) DECLARACIÓN DE CONFORMIDAD DE LA CE
(POR) DECLARAÇÃO DE CONFORMIDADE EC
(ITA) DICHIARAZIONE DI CONFORMITA' CE
(DEU) EG-KONFORMITÄTSERKLÄRUNG
(NLD) EG- VERKLARING VAN OVEREENSTEMMING
(POL) EC DEKLARACJA ZGODNOŚCI
(SWE) CE DEKLARATION

(ENG): Hereby declares that: / The device:
(FRA): Déclare par la présente que: / L'appareil:
(SPA): Declaro que: / El aparato:
(POR): Vimos por este meio declarar: / O aparelho:
(ITA): Con la presente dichiaro che: / Dispositivo:
(DEU): Hiermit wird erklärt, dass: / Die folgenden Erzeugnisse:
(NLD): Hierbij verklaart dat: / Het apparaat:
(POL): Niniejszym oświadczam, że: / Urządzenia:
(SWE): Härmed deklaras att: / Enheten:

(DAN) EF-VERENSTEMMELSESEKRLÆRING
(NOR) ECSAMSVERKLARING
(FIN) EY-VAATIMUSTENMIUKAISUUSVAKUUTUS
(RUS) ДЕКЛАРАЦИЯ О СООТВЕТСТВИИ ЕС
(TUR) CE STANDARDİZASYON BEYANI
(CES) PROHLÁŠENÍ O SHODĚ
(SLK) PREHLÁSENIE O ZHODE
(ELL) ΗΛΟΣΗ ΣΥΜΜΟΡΦΩΣΗΣ ΜΕ ΕΕ
(HUN) CE - MEGFELELŐSÉGI NYILATKOZAT

(DAN): Erklærer herved at: / enheten:
(NOR): Erklærer herved at: / enheten:
(FIN): Vakuutamme täten: / Että tuote:
(RUS): Настоящим заявляем, что: / Устройство:
(TUR): Beyan ederiz ki: / Cihaz:
(CES): Níže prohlašujeme, že: / Výrobek:
(SLK): Týmto prehlasujeme, že: / Výrobok:
(ELL): Δηλώνει ότι: / Η συσκευή:
(HUN): Ez kijelenti, hogy: / Az eszköz:

(ENG) Type(s): (FRA) Type(s): (SPA) Tipo(s): (POR) Tipo: (ITA) Tipo: (DEU) Type(s): (NLD) Typen: (POL) Typ: (SWE) Typ: (DAN) Typ: (NOR) Typ: (FIN) Tuotteen: (RUS) Тип: (TUR) Tip: (CES) Typ: (SLK) Typ: (ELL) Τύπος: (HUN) Típus:	BCL1C51B	(ENG) Product: (FRA) Produit: (SPA) Producto: (POR) Produto: (ITA) Prodotto: (DEU) Produkt: (NLD) Product: (POL) Produkt: (SWE) Produkten: (DAN) Produktet: (NOR) Produktet: (FIN) Tuotteen: (RUS) Изделие: (TUR) Ürün: (CES) Výrobek: (SLK) Výrobok: (ELL) Προϊόν: (HUN) Termék:	Charger Chargeur Cargador Carregador Caricabatterie Ladegerät Lader Ladowarka Laddare Oplader Lader Laturi Зарядное устройство İçin sarj cihazı Nabiječka Nabijačka Φορτιστή μπαταρίας Töltő	(ENG) Year: (FRA) Année: (SPA) Año: (POR) Ano: (ITA) Anno: (DEU) Baujahr: (NLD) Jaar: (POL) Rok: (SWE) År: (DAN) År: (NOR) År: (FIN) Vuosi: (RUS) Год: (TUR) Sene: (CES) Rok: (SLK) Rok: (ELL) Χρόνος: (HUN) Év:	2021
---	-----------------	--	---	---	-------------

(ENG) Was manufactured in conformity with the provisions in the:
(FRA) A été fabriqué en conformité avec les dispositions des:
(SPA) Está fabricada según las disposiciones de:
(POR) Foi fabricado em conformidade com os pressupostos:
(ITA) Prodotto in conformità con le disposizioni:
(DEU) In Übereinstimmung mit den Bestimmungen der:
(NLD) Is vervaardigd in overeenstemming met de bepalingen in de:
(POL) Został wyprodukowany zgodnie z przepisami
(SWE) Producerats enligt bestämmelserna i följande direktiv:

(DAN) Produisert i samsvar med bestemmelsene i:
(NOR) Produisert i samsvar med bestemmelsene i:
(FIN) On valmistettu noudattaen säännöksiä:
(RUS) Было произведено в соответствии с положениями:
(TUR) Aşağıdaki Standartlara uygun üretilmiştir:
(CES) Byl vyroben ve shodě s předpisy:
(SLK) Bol vyrobený v zhode s predpismi:
(ELL) Κατασκευάστηκε σύμφωνα με τις διατάξεις του:
(HUN) A következő rendelkezéseknek megfelelően gyártották:

Directive 2014/30/EU, 2014/35/EU

(ENG) Person authorized to compile the technical file:
(FRA) Personne autorisée à constituer le dossier technique:
(SPA) Persona facultada para elaborar el expediente técnico:
(POR) Pessoa autorizada para elaborar o dossier técnico:
(ITA) Persona autorizzata a compilare la pratica tecnica:
(DEU) Bevollmächtigte(r) zum Zusammenstellen technischer Unterlagen:
(NLD) Persoon die is gemachtigd het technisch dossier samen te stellen:
(POL) Osoba odpowiedzialna za zestawianie pliku technicznego:
(SWE) Person som är behörig att sammanställa den tekniska dokumentationen:
(DAN) Person bemyndiget til at udarbejde tekniske beskrivelser:
(NOR) Autorisert person for utarbeidelse av den tekniske filen:
(FIN) Henkilö on valtuutettu kokoamaan teknisen tiedoston:
(TUR) Teknik dosyayı düzenlemeye yetkili kişi:
(RUS) Лицо, уполномоченное на составление технической документации:
(CES) Autorizovaná osoba pro sestavení technického spisu:
(SLK) Osoba zodpovedná za vypracovanie technickej dokumentácie:
(ELL) Άτομο εξουσιοδοτημένο να καταρτίσει τον τεχνικό φάκελο:
(HUN) A műszaki dokumentáció összeállítására feljogosított személy:

Sergio García
Quality manager



Date: August 4th, 2021

- CS** Pro stažení kompletního návodu přejděte na stránku www.bahco.com nebo naskenujte QR kód
- DE** Um die gesamte Bedienungsanleitung herunterzuladen, gehen Sie zu www.bahco.com oder scannen Sie den QR-Code
- DA** Download hele brugsanvisningen ved at besøge www.bahco.com eller scan QR-koden
- EL** Για λήψη του εγχειριδίου οδηγιών μεταβείτε στη διεύθυνση www.bahco.com ή σαρώστε τον κωδικό QR
- EN** For downloading the full instruction manual go to www.bahco.com or flash the QR-code
- ES** Para descargar el manual de instrucciones completo, vaya a www.bahco.com o escanee el código QR.
- FI** Täydellisen käyttöohjeen saat osoitteesta www.bahco.com tai skannaamalla QR-koodin
- FR** Pour télécharger le manuel d'instructions complet, rendez-vous sur www.bahco.com ou scannez le code QR
- HR** Za preuzimanje korisničkog priručnika u cijelosti idite na www.bahco.com ili skenirajte crtični kod
- HU** A használati útmutató letöltéséhez lépjen a www.bahco.com oldalra, vagy olvassa le a QR-kódot.
- IT** Per scaricare il manuale di istruzioni completo andare sul sito www.bahco.com oppure scansionare il codice QR
- NL** Om de complete gebruiksaanwijzing te downloaden, ga naar www.bahco.com of gebruik de QR-code
- NO** Besøk www.bahco.com for å laste ned hele instruksjonshåndboken, eller les av QR-koden
- PL** Aby pobrać cały podręcznik obsługi, wejdź na stronę www.bahco.com lub zeskanuj kod QR
- PT** Para descarregar o manual de instruções na íntegra, vá a www.bahco.com ou leia o código QR
- RO** Pentru descărcarea manualului complet de instrucțiuni, accesați www.bahco.com sau scanați codul QR
- SV** Hämta den fullständiga instruktionshandboken på www.bahco.com/sv-se/ eller läs av QR-koden.
- SK** Ak si chcete stiahnuť celý návod na použitie, kliknite na www.bahco.com alebo naskenujte QR kód
- SL** Za prenos celotnega priročnika z navodili za uporabo pojdite na www.bahco.com ali poskenirajte QR-kodo.
- TR** Tam kullanım kılavuzunu indirerek için www.bahco.com adresine gidin veya QR kodunu gönderin



Follow the fish! www.bahco.com

